

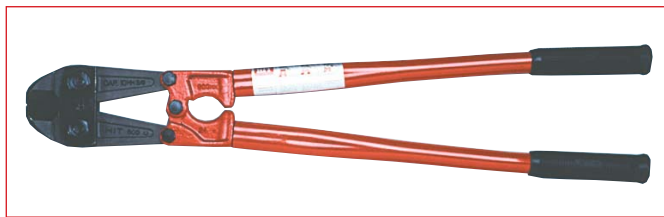

Liste de prix
2015
Prijslijst



Coupe-boulons / Boutensnijder **STANDARD BLACK**

REF.	HRC40	V.E.	€	EAN
NBC 300	4 mm	12	30,00	495383000001 5
NBC 350	5 mm	12	38,00	495383000002 2
NBC 450	6 mm	6	45,00	495383000003 9
NBC 600	8 mm	6	57,00	495383000004 6
NBC 750	9 mm	2	77,00	495383000006 0
NBC 900	10 mm	2	104,00	495383000007 7
NBC 1050	11 mm	1	140,00	495383000009 1

Jeu de couteaux de rechange / Stel messen

NBCC 300	-	17,00	495383000011 4
NBCC 350	-	22,00	495383000012 1
NBCC 450	-	26,00	495383000013 8
NBCC 600	-	34,00	495383000014 5
NBCC 750	-	44,00	495383000016 9
NBCC 900	-	57,00	495383000017 6
NBCC 1050	-	73,00	495383000019 0



Coupe-boulons / Boutensnijder **SPECIAL SILVER**

REF.	HRC48	V.E.	€	EAN
NBC-S 300	4 mm	12	35,00	495383000301 6
NBC-S 350	5 mm	12	44,00	495383000302 3
NBC-S 450	5,5 mm	6	52,00	495383000414 3
NBC-S 600	7 mm	6	63,00	495383000415 0
NBC-S 750	8 mm	2	95,00	495383000417 4
NBC-S 900	9 mm	2	129,00	495383000418 1
NBC-S 1050	10 mm	1	155,00	495383000419 8

Jeu de couteaux de rechange / Stel messen

NBCC-S 300	-	20,50	495383000361 0
NBCC-S 350	-	25,00	495383000362 7
NBCC-S 450	-	33,00	495383000474 7
NBCC-S 600	-	42,00	495383000475 4
NBCC-S 750	-	53,00	495383000477 8
NBCC-S 900	-	75,00	495383000478 5
NBCC-S 1050	-	90,00	495383000479 2



Cisaille pour ronds et treillis / Betonijzertang

REF.	HRC40	V.E.	€	EAN
RCA 800	8 mm	4	117,00	495383000801 1

Jeu de couteaux de rechange / Stel messen

RCCA 800	-	60,00	495383000810 3
-----------------	---	--------------	----------------

26



Cisaille pour tiges filetées / Snijtang voor draadeinden

REF.	Cap.	V.E.	€	EAN
TRC 10	Ø 10 mm - 1.50 pitch	-	233,00	495383001019 9
Matrices / Matrijzen				
TRCC 6	6 mm	-	23,00	495383001037 3
TRCC 8	8 mm	-	23,00	495383001038 0
TRCC 10	10 mm	-	23,00	495383001039 7

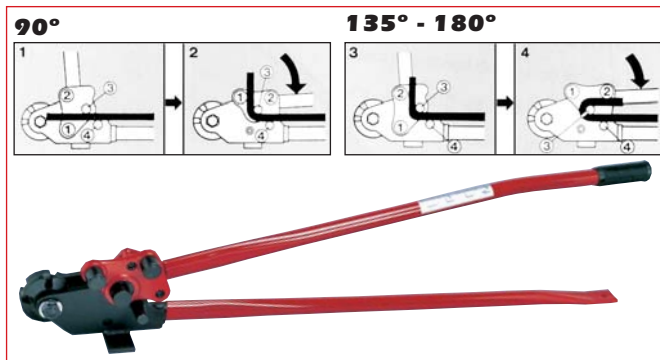

Cisaille-cintreuse pour ronds à béton

Plooi- en snijtang voor betonijzer

REF.	HRC48	V.E.	€	EAN
RC 16-B	16 mm	1	332,00	495383001015 1
Jeu de couteaux de rechange / Stel messen				
RCC 16-B	-	142,00	495383001115 8	

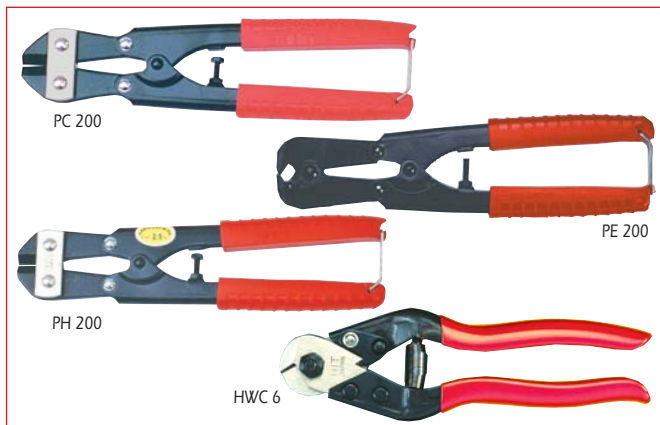

Cisailles de poche / Zaksnijtangen

REF.	HRC40	V.E.	€	EAN
PC 200	2 mm	6	18,00	495383004016 5
PE 200	2 mm	6	24,00	495383004046 2
PH 200	3 mm	6	19,00	495383004026 4
HWC 6	3 mm	6	25,00	495383002031 0

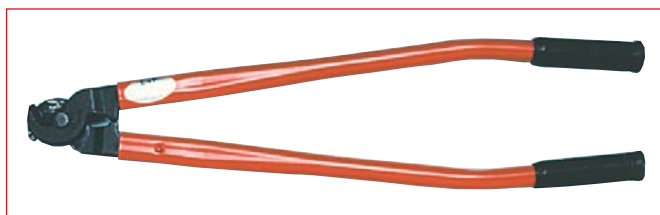

Cisaille pour câble acier / Snijtang voor staalkabel

REF.	Cap.	V.E.	€	EAN
W 16	Ø 16 mm	1	62,00	495383003005 0

Prix en € hors TVA



Cisailles pour câble acier / Snijtangen voor staalkabel

REF.	Cap.	V.E.	€	EAN
HWC 9	9 mm	1	84,00	495383002042 6
HWC 12	12 mm	1	178,00	495383002033 4
HWC 16	16 mm	1	252,00	495383002044 0

Jeu de couteaux de rechange / Stel messen

HWCC 9	1	60,00	495383002042 6
HWCC 12	1	83,00	495383002043 3
HWCC 16	1	91,00	495383002044 0

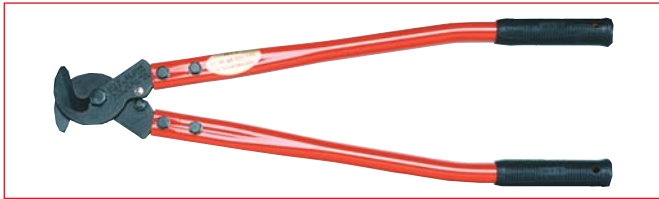

Cisailles de câble aluminium & cuivre Scharen voor koper- en alu-kabels

REF.	Cap. Alu	Cap. Copper	€	EAN
SCR 250	350 mm ²	250 mm ²	82,00	495383003103 3
SCR 500	650 mm ²	300 mm ²	125,00	495383003105 7

Jeu de couteaux de rechange / Stel messen

SCC 250			53,00	495383003163 7
SCC 500			83,00	495383003165 1



Cisailles de câble à double articulation Kabelsnijtang met dubbel scharnierpunt

REF.	Cap.	V.E.	€	EAN
CC 30	Ø 30 mm	1	141,00	495383003307 5
CC 50	Ø 50 mm	1	245,00	495383003309 9

Jeu de couteaux de rechange / Stel messen

CCC 30	1	85,00	495383003367 9
CCC 50	1	133,00	495383003369 3

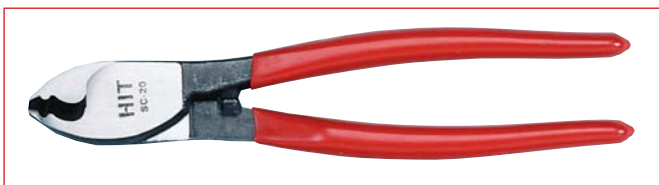

Pince coupe-câble compactes / Kabelsnijtangen

REF.	L	V.E.	€	EAN
SC 10	160 mm	6	21,50	495383003401 0
SC 20	210 mm	6	23,50	495383003402 7
SC 30	240 mm	6	28,00	495383003403 4

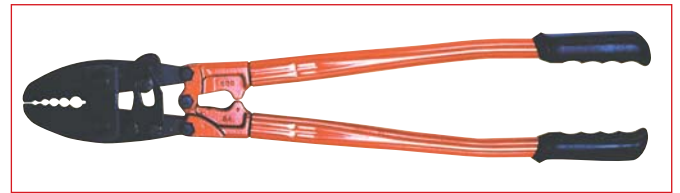

Pincas à cosses avec système de coupe

Kabelschoentang met snijsysteem

REF.	Pour bague / Voor ring	€	EAN
CT 600	1/16", 3/32", 1/8", 5/32", 3/16"	125,00	495383007514 3
CT 750	5/32", 1/4", 5/16"	149,00	495383007516 7

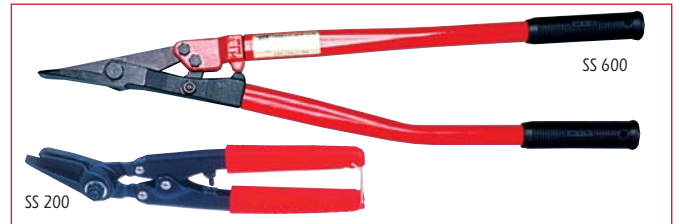

Coupe-feuillard / Bandijzerscharen

REF.	Cap.	V.E.	€	EAN
SS 200	32x0,9 mm	6	30,00	495383007502 0
SS 600	51x1,3 mm	1	120,00	495383007506 8



Cisailles à tôles, articulées / Plaatscharen met scharnierpunt

REF.	L	V.E.	€	EAN
Coupe droite / Rechte snede				
MS 260-S	250 mm	6	26,00	495383000307 8
Coupe à droite / Rechtse snede				
MS 260-R	250 mm	6	26,00	495383003027 2
Coupe à gauche / Linkse snede				
MS 260-L	250 mm	6	26,00	495383003017 3



Pincas à riveter / Klinktangen

REF.	Pour rivets / Voor klinknagels	€	EAN
HR 001	2.4 mm/3.2 mm/4.0 mm/4.8 mm	46,00	495383018011 3
HR 003	3.2 mm/4.0 mm/4.8 mm	100,00	495383018023 6
HR 005	3.2 mm/4.0 mm/4.8 mm	148,00	495383018025 0

Clés serre-tube / Pijptangen

REF.	Ø	V.E.	€	EAN
ALP-350	2"	1	60,00	49538302104 0
ALP-450	3"	1	77,00	495383021306 4
ALP-600	3 1/2"	1	106,00	495383021307 1
ALP-900	4"	1	197,00	495383021308 8

