

JORDAN



METEC



Standard-Catalog 2014/2015



high class

work equipment

Dear Customer,

with this catalog we present a current overview of our series products, the standard range of quality workshop equipment.

As part of the German group Jordan, we have

- 25 years cutting-edge technology in sheet metal construction
 - and for over 20 years quality workshop equipment
- the strong brand METEC - Made in Germany -

At three locations in Germany we produce for you customized products and solutions to enhance your own performance.

On the following pages you will discover

- many very good old friends, our established bestsellers
- interesting innovations, our innovative developments
- the excellent solutions from our individual systems
- the user-friendly ways of 3D tools pcon[®].planner
- an insight into the diverse range of our sheet metal manufacturing

All products are finished in function, design and ergonomics, technically thought out, highly flexible, durable, sturdy and highly resilient.

In addition to the series products shown here always glad to fulfill almost any individual wish on request.

Use our products and our capabilities to your advantage anywhere in your business, whether, in the workshop, on the machine, in the laboratory, in the warehouse, in the social space, or at any other point in the value chain.

German top quality is always worthwhile.

Talk to us.

The local dealer, and our experts in-house will gladly advise you.

Your team of Jordan GmbH METEC Blechsysteme











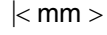

Content

<u>Product / Series</u>	<u>Page</u>
Work Bench - Series 30	4
Work Bench - Series 20, 22	8
Work Bench - Series 23	10
Work Bench - Series 230	12
Workshop Roll Container - Series 61	13
Drawer Cabinets - Series 550	14
Drawer Cabinets - Series 562	16
Drawer Cabinets - Series 560	17
Workshop Table Trolleys - Series 63	18
Mobile Workbench - Series 66	20
Workshop Trolleys - Series 60	21
Workshop Trolleys - Series 64	22
Workshop Trolleys - Series 67	23
Workshop Trolleys - Series MaJor	24
Workshop Trolleys - Accessories	26
Workshop Trolleys ALU	27
QM-Mobil	28
PC-Locker - Series 69	
Hinged Doors - and	29
Environment Safety Cabinets - Series 52	30
Lockers - Series 53	34
Bench - Series 54	35
Tool Wall Cupboard - Series 58	35
Tool Holders &	
Tool Hooks to clip	36
Drawer Cabinets - Series Individual	40

LEGEND

	Weight (total)
	Strength work disc
	Width
	Door
	Drawer
	Shelves
	Vertical drawer
	Clothes rail

Available colours



RAL 6011
Reseda green



RAL 5010
Gentian blue

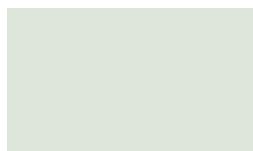

RAL 7035
Light grey



RAL 7016
Anthracite grey



RAL 3003
Ruby red



RAL 3020
Traffic red

Individual colouring available at extra charge according to the RAL chart (the colours shown are the standard colours of the METEC production).

Delivery with standard colouring as specified in the article description.

Colours can differ on the pictures.

Please indicate non-standard colour choices when ordering.



Workbench Modular system Series 30

- Sturdy construction with worktops in beech wood, laminated, 40 or 50 mm thick, surface additionally protected by linseed oil varnish.
- Base frame elements can be optionally assembled right or left.
- Stands made from U-steel section with bottom plate.
- To increase stability, feet can be bolted to the floor.
- Drawers in sheet steel, on roller bearings, load capacity per Drawer 60 kg, secured against falling out, fixed open position and removal position, with full-width plastic handle with identification strip
- Drawers individually partitionable, Drawer size inside: W 459 x D 539 mm.
- Lockable with cylinder lock and central locking.
- Dimensions: H 840 / 850, W 1500 / 2000, D 700 mm
- Delivery disassembled, for self-assembly, mounting material included.
- Standard colour RAL 6011/6011







30000 Workbench basic model

- 1 worktop
- 2 workbench stands 800 mm height (Part No.: 31000)

Code	No.	mm $\bar{\text{I}}$	H	W	D	 kg
9500170	30000/84522	40	840	1500	700	47,0
9500250	30000/84622	40	840	2000	700	58,0
1434888	30000/84523	50	850	1500	700	55,0
1434896	30000/84623	50	850	2000	700	68,0

30100 Workbench with 1 drawer





- 1 worktop
- 2 workbench stands 800 mm height (Part.-No.: 31000)
- 1 drawer with case

Code	No.	mm $\bar{\text{I}}$	H	W	D	Construction	 kg
9500760	30100/84522	40	840	1500	700	1  140	57,0
9500840	30100/84622	40	840	2000	700	1  140	68,0
1434926	30100/84523	50	850	1500	700	1  140	65,0
1434934	30100/84623	50	850	2000	700	1  140	78,0



30320 Workbench with 1 drawer cabinet

- 1 workbench top
- 2 workbench stands 800 mm height (Art.-No.: 31000)
- 1 drawer cabinet

Code	No.	mm $\bar{\text{I}}$	H	W	D	Construction	 kg
9501300	30320/84522	40	840	1500	700	3  2x 90, 1x 180	79,0
9501490	30320/84622	40	840	2000	700	3  2x 90, 1x 180	90,0
1434985	30320/84523	50	850	1500	700	3  2x 90, 1x 180	87,0
1434993	30320/84623	50	850	2000	700	3  2x 90, 1x 180	100,0







30410 Workbench with drawer cabinet

- 1 worktop
- 2 workbench stands 800 mm height (Part No.: 31000)
- 1 drawer cabinet

Code	No.	mm \bar{I}	H	W	D	Construction	
9501650	30410/84522	40	840	1500	700	4  90	82,0
9501730	30410/84622	40	840	2000	700	4  90	93,0
1435043	30410/84523	50	850	1500	700	4  90	90,0
1435041	30410/84623	50	850	2000	700	4  90	103,0

30820 Workbench with drawer cabinet



- 1 worktop
- 1 workbench stands 800 mm height (Part No.: 31000)
- 1 drawer cabinet

Code	No.	mm \bar{I}	H	W	D	Construction	
9571270	30820/84522	40	840	1500	700	7  1x 45 5x 90 1x 180	97,0
9571350	30820/84622	40	840	2000	700	7  1x 45 5x 90 1x 180	107,0
1435159	30820/84523	50	850	1500	700	7  1x 45 5x 90 1x 180	115,0
1435167	30820/84623	50	850	2000	700	7  1x 45 5x 90 1x 180	118,0



30840 Workbench with drawer cabinet

- 1 worktop
- 1 workbench stands 800 mm height (Part No.: 31000)
- 1 drawer cabinet

Code	No.	mm \bar{I}	H	W	D	Construction	
9583010	30840/84622	40	840	2000	700	6  1x 45 3x 90 2x 180	104,0
1435205	30840/84623	50	850	2000	700	6  1x 45 3x 90 2x 180	115,0



30850 Workbench with 2 drawer cabinets

- 1 worktop
- 2 drawer cabinets

Code	No.	mm \bar{I}	H	W	D	Construction	
9583280	30850/84622	40	840	2000	700	6  1x 45 3x 90 2x 180 4  2x 90 1x 225 1x 270	141,0
1435213	30850/84623	50	850	2000	700	6  1x 45 3x 90 2x 180 4  2x 90 1x 225 1x 270	152,0



30860 Workbench with 2 drawer cabinets

- 1 worktop
- 2 drawer cabinets

Code	No.	mm \bar{I}	H	W	D	Construction	
9583360	30860/84622	40	840	2000	700	5  1x 45 1x 90 3x 180 5  1x 45 1x 90 3x 180	144,0
1435221	30860/84623	50	850	2000	700	5  1x 45 1x 90 3x 180 5  1x 45 1x 90 3x 180	155,0



31000-31200 Workbench legs

- In strong, U-section steel, 80 x 50 x 2 mm
- With lower crossbar (230 mm high) also suitable as support for additional shelving
- Drilled footplate for bolting to the floor
- Including installation material
- Standard colour RAL 6011

Code	No.	H	D	 kg
2119137	31100	750	630	7,3
9555740	31000	800	630	7,6
2076799	31200	850	630	8,0

31300 Workbench leg - height adjustable

- In strong U-section steel
- Height adjustable in 25 mm steps
- Including installation material
- Standard colour RAL 6011

Code	No.	H	D	 kg
2119188	31300	600-950	630	9,5





31610-31620 Base for drawer cabinets

- For drawer cabinets and sheet steel cupboards of series 32
- In sheet steel
- Standard colour RAL 6011

Code	No.	H	W	D	 kg
1822985	31610	50	533	590	2,3
1822993	31620	100	533	590	4,1

84522-84623 Laminated beech wood worktop Multiplex

- Will not crack or warp
- Four-ply glued wood, clear varnished

Code	No.	mm 	W	D	 kg
9560150	84522	40	1500	700	24,0
9567240	84523	50	1500	700	31,0
9560230	84622	40	2000	700	32,0
9567320	84623	50	2000	700	41,0





Drawer cabinets



- All drawers are in sheet steel mounted on rollers
- With slots 34 mm high and 34 mm apart, with perforated drawer bottoms
- Load capacity 60 kg

- Secured against falling out, fixed open position and removal position
- Fitted with full-width plastic handle with plastic caps at each end
- Contents identification strip with replaceable paper strip and transparent plastic foil









32110-32210 Single Drawer with case

- For bolting beneath the worktop
- Dimensions: H 90/140 x D 600 mm

Code	No.	 H	useful height	W	D	
9550000	32110	140	100	510	600	10,0
9561710	32210	90	80	535	600	10,0

32320-32340 Drawer cabinet H 380





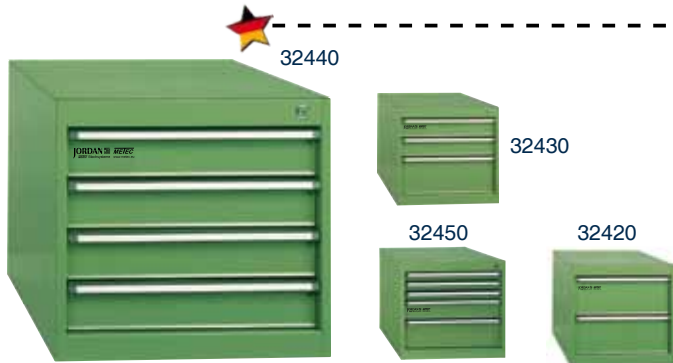

- Dimensions: H 380 x W 535 x D 600 mm
- Drawer size inside: W 459 x D 539 mm

Code	No.	 H	H	W	D	
9561980	32320	2  1x 90 1x 180	380	535	600	23,0
9562790	32321	2  135	380	535	600	23,0
9550190	32330	3  90	380	535	600	26,0
9562870	32340	4  2x 45 2x 90	380	535	600	29,0









32420-32450 Drawer cabinet H 470

- Dimensions: H 470 x W 535 x D 600 mm
- Drawer size inside: W 459 x D 539 mm

Code	No.	 H	H	W	D	
9563090	32420	2  180	470	535	600	26,0
9550270	32430	3  2x 90 1x 180	470	535	600	30,0
9550350	32440	4  90	470	535	600	34,0
9562950	32450	5  3x 45 1x90 1x 135	470	535	600	37,0

32630-32660 Drawer cabinet H 655





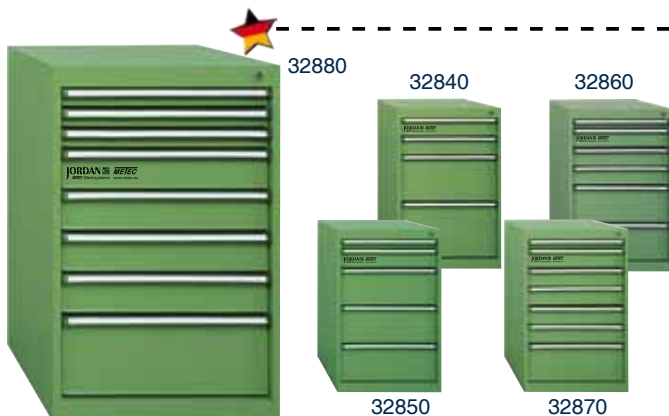

- Dimensions: H 655 x W 535 x D 600 mm
- Drawer size inside: W 459 x D 539 mm

Code	No.	 H	H	W	D	
9563170	32630	3  180	655	535	600	39,0
9563250	32640	4  2x 90 2x 180	655	535	600	42,0
9563330	32650	5  4x 90 1x 180	655	535	600	45,0
9563410	32660	6  90	655	535	600	48,0



32840-32880 Drawer cabinet H 800

- Dimensions: H 800 x W 535 x D 600 mm
- Drawer size inside: W 459 x D 539 mm

Code	No.	 H	H	W	D	
9580850	32840	4  2x 90 1x 225 1x 270	800	535	600	49,0
9563680	32850	5  1x 45 1x 90 3x 180	800	535	600	52,0
9563760	32860	6  1x 45 3x 90 2x 180	800	535	600	55,0
9550430	32870	7  1x 45 5x90 1x 180	800	535	600	58,0
9557950	32880	8  3x 45 4x90 1x 135	800	535	600	61,0



Workbenches with welded base - Series 20, 22

- Worktop made of laminated beech multiplex 40 or 50 mm thick, Plate surface additionally protected by linseed oil varnish
- Base frame made of sturdy weldet square steel tubing. Distance from lower crossbar to the ground 100 mm
- To increase the stability of the feet can be bolted to the floor.
- Drawers and cabinets flush welded in the housing, lockable with cylinder lock and central locking

- Drawers on roller bearings, partial extension telescopic 90%, to 60 kg load
- Size inside: W 459 x D 539 mm, with continuous plastic handles with labeling strips, individually partitionable
- Dimensions: H 840/850, W 1500/2000, D 700 mm.
- Distributed load on the countertop about 500 kg evenly
- Standard colour RAL 7016/7035

20103 Workbench with drawer

- 1 worktop
- 1 base frame 800 mm height
- 1 single drawer



Code	No.	mm $\bar{\text{I}}$	H	W	D	Construction	
9572240	20103/84522	40	840	1500	700	1  140	63,0
9572320	20103/84622	40	840	2000	700	1  140	76,0
1434527	20103/84523	50	850	1500	700	1  140	72,0
1434691	20103/84623	50	850	2000	700	1  140	87,0

20403 Workbench with drawer cabinet

- 1 worktop
- 1 base frame 800 mm height
- 1 drawer cabinet



Code	No.	mm $\bar{\text{I}}$	H	W	D	Construction	
9572830	20403/84522	40	840	1500	700	4  90	88,0
9572910	20403/84622	40	840	2000	700	4  90	101,0
1434551	20403/84523	50	850	1500	700	4  90	96,0
1434721	20403/84623	50	850	2000	700	4  90	112,0

20003 Workbench basic model

- 1 worktop
- 1 base frame 800 mm height



Code	No.	mm $\bar{\text{I}}$	H	W	D	
9571940	20003/84522	40	840	1500	700	53,0
9572080	20003/84622	40	840	2000	700	66,0
1434519	20003/84523	50	850	1500	700	61,0
1434683	20003/84623	50	850	2000	700	77,0

22663 Workbench with drawer cabinet and sheet steel cupboard

- 1 worktop
- 1 base frame 800 mm height
- 1 sheet steel cupboard (H 655 x W 535 x D 600 mm)
- 1 drawer cabinet with 3 drawers (H 655 x W 535 x D 600 mm)



Code	No.	mm $\bar{\text{I}}$	H	W	D	Construction	
9584250	22663/84522	40	840	1500	700	1  1  3  180	117,0
1434659	22663/84523	50	850	1500	700	1  1  3  180	125,0



20613 Workbench with sheet steel cupboard

- 1 worktop
- 1 base frame 800 mm height
- 1 sheet steel cupboard with drawer

Code	No.	mm $\bar{\text{I}}$	H	W	D	Construction	
9572590	20613/84522	40	840	1500	700	1  1  1  90	78,0
9572670	20613/84622	40	840	2000	700	1  1  1  90	91,0
1434586	20613/84523	50	850	1500	700	1  1  1  90	86,0
1434772	20613/84623	50	850	2000	700	1  1  1  90	102,0

22683 Workbench with 2 sheet steel cupboards

- 1 worktop
- 1 base frame 800 mm height
- 2 sheet steel cupboards with 1 drawer each (H 655 x W 535 x D 600 mm)
- RAL 7016/7035

Code	No.	mm $\bar{\text{I}}$	H	W	D	Construction	
9584410	22683/84522	40	840	1500	700	1  1  1  90 1  1  1  90	103,0
1434675	22683/84523	50	850	1500	700	1  1  1  90 1  1  1  90	112,0



22673 Workbench with 2 drawer cabinets















- 1 worktop
- 1 base frame 800 mm height
- 2 drawer cabinets with 4 drawer each (H 655 x W 535 x D 600 mm)

Code	No.	mm $\bar{\text{I}}$	H	W	D	Construction	
9584330	22673/84522	40	840	1500	700	4  2x 90 2x 180 4  2x 90 2x 180	137,0
1434667	22673/84523	50	850	1500	700	4  2x 90 2x 180 4  2x 90 2x 180	145,0



22643 Workbench with drawer cabinet and 2 Sheet steel cupboards















- 1 worktop
- 1 base frame 800 mm height
- 1 drawer cabinet with 3 drawers
- 2 sheet steel cupboards with 1 drawer each

Code	No.	mm $\bar{\text{I}}$	H	W	D	Construction	
9585220	22643/84622	40	840	2000	700	1  1  1  90 3  180 1  1  1  90	155,0
1434845	22643/84623	50	850	2000	700	1  1  1  90 3  180 1  1  1  90	166,0



22633 Workbench with 2 sheet steel cupboards and shelf unit



















- 1 worktop
- 1 base frame 800 mm height
- 2 sheet steel cupboards with 1 drawer each H 655 x W 535 X D 600 mm
- 1 central shelf unit W 530 x D 600 mm

Code	No.	mm $\bar{\text{I}}$	H	W	D	Construction	
9599600	22633/84622	40	840	2000	700	1  1  1  90 1  530 x 600 1  1  1  90	137,0
1434837	22633/84623	50	850	2000	700	1  1  1  90 1  530 x 600 1  1  1  90	148,0



20533 Workbench with 3 sheet steel cupboards

- 1 worktop
- 1 base frame 800 mm height
- 3 sheet steel cupboards with 1 drawer each, front panel height 90 mm

Code	No.	mm $\bar{\text{I}}$	W	D	Construction	
9585140	20533/84622	40	840	700	1  1  1  90 1  1  1  90 1  1  1  90	141,0
1434756	20533/84623	50	850	700	1  1  1  90 1  1  1  90 1  1  1  90	152,0









Workbenches - Compact Series 23

- For the individual requirements found in practice.
- Base made from sturdy welded sheet steel, optionally available with doors and drawers, with holes for possible bolting of the workbench to the floor. Optionally with PVC-floor gliders with integrated height compensation, for use on uneven floors.
- Worktop in multiplex laminated beech wood, 40 mm thick, maximum load 300 kg, evenly distributed.

- Drawers on roller bearings, to take 60 kg loading, drawer size inside: W 459 x D 539 mm, individually partitionable, front panels with plastic handles and identification strip. Drawer extension about 90% extractable.
- Central locking with cylinder lock.
- Workbench is prepared for height adjustment of the worktop (only as initial equipment, subsequent equipping not possible).
- Dimensions: H 840 x W 1500/2000 x D 700 mm
- Standard colour RAL 7035/5010







23110 Workbench

Code	No.	mm $\overline{\text{I}}$	H	W	D	Construction	
1480391	23110/ 84522	40	840	1500	700	1  1  90 1  1  90	97,0







23120 Workbench

Code	No.	mm $\overline{\text{I}}$	H	W	D	Construction	
1480405	23120/ 84522	40	840	1500	700	3  180 1  1  90	104,0





23130 Workbench

Code	No.	mm $\overline{\text{I}}$	H	W	D	Construction	
1480413	23130/ 84522	40	840	1500	700	1  1  1  90	91,0







23140 Workbench

Code	No.	mm $\overline{\text{I}}$	H	W	D	Construction	
1480421	23140/ 84522	40	840	1500	700	3  180 1 	98,0



23260 Workbench

Code	No.	mm $\overline{\text{I}}$	H	W	D	Construction	
1480448	23260/ 84622	40	840	2000	700	1  1  90 1  1  1  90	128,0



23270 Workbench

Code	No.	mm $\overline{\text{I}}$	H	W	D	Construction	
1480456	23270/ 84622	40	840	2000	700	1  3  180 1 	129,0

23280 Workbench



Code	No.	mm	H	W	D	Construction	kg
1480464	23280/ 84622	40	840	2000	700	1 1 90 3 180 1 1 90	135,0



23290 Workbench

Code	No.	mm	H	W	D	Construction	kg
1480472	23290/ 84622	40	840	2000	700	1 1 90 3 180 1 1 90	141,0



58660 Shelf for workbenches Series 23 + 66

- In zinc-plated sheet steel with folded edges for safety
- Height adjustable, including attachment material



Code	No.	W	D	kg
1481142	58660	480	550	2,5

23111-23222 Height adjustment for workbenches Series 23

- For continuous height adjustment of the worktop up to max. 200 mm



Code	No.	for Workbench width	kg
1480480	23111	1500	16,0
1480499	23222	2000	21,0



Drawer Dividers in sets

- To fit all workshop trolleys of the series 30, 20, 22, 23
- Dividers in sheet steel, powder-coated
- Cross pieces in zinc-plated sheet steel, edges rounded
- Drawer size inside: 459 x 539 mm



82107-82115 Divider set H 50

- For drawers with 90 mm front panel height

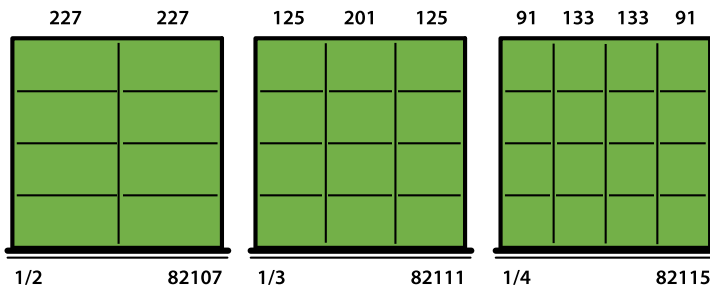

Code	No.	Content	Divided into	kg
9581820	82107	1 divider, 6 cross pieces	1/2	1,0
9581900	82111	2 dividers, 9 cross pieces	1/3	1,5
9582040	82115	3 dividers, 12 cross pieces	1/4	1,8

82207-82215 Divider set H 100

- For Drawers with 135/180 mm front panel height

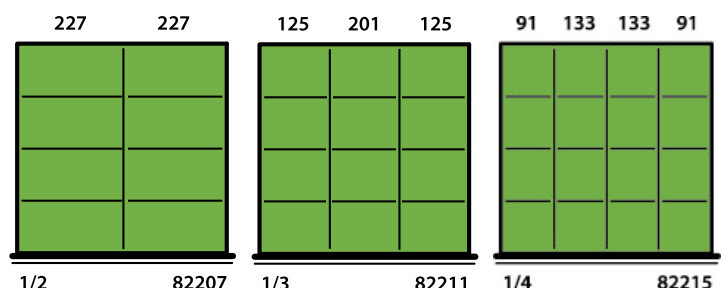

Code	No.	Content	Divided into	kg
9582120	82207	1 divider, 6 cross pieces	1/2	2,0
9582200	82211	2 dividers, 9 cross pieces	1/3	2,9
9582390	82215	3 dividers, 12 cross pieces	1/4	3,8





Workbenches Modular Series 230

- Base made from sturdy welded sheet steel, adjustable in height in steps of 25 mm, with PVC-floor gliders with integrated height compensation, for use on uneven floors
- Worktop in multiplex laminated beech wood, 40 mm thick, maximum load 200 kg, evenly distributed
- Drawers on telescopic full extension, quick opening, allows fast removal of the drawer by releasing via two levers and if required swapping drawers, load capacity per drawer approx. 40 kg, individually partitionable, front panels with plastic handles and identification strip

- Drawer size inside:
W 986 x D 510 mm (wide drawer)
W 459 x D 510 mm (small drawer)
- Central locking with cylinder lock
- Dimensions: H 840-940 x W 1500/ 2000 x D 700 mm
- Standard colour RAL 7035/5010







23410 Workbench

Code	No.	mm $\bar{\text{I}}$	W	D	Construction	
2900207	23410 /84522	40	1500	700	4  1x 75 3x 150 4  2x 75 1x 150 1x 225	125,0



23420 Workbench

Code	No.	mm $\bar{\text{I}}$	W	D	Construction	
2900208	23420 /84522	40	1500	700	2  2x 75 4  3x 75 1x 150 2  1x 150 1x 225	111,0



23430 Workbench

Code	No.	mm $\bar{\text{I}}$	W	D	Construction	
2900209	23430 /84522	40	1500	700	4  2x 75 1x 150 1x 225	97,0



23510 Workbench

Code	No.	mm $\bar{\text{I}}$	W	D	Construction	
2900210	23510 /84622	40	2000	700	4  1x 75 3x 150 4  2x 75 1x 150 1x 225	136,0





23520 Workbench

Code	No.	mm $\bar{\text{I}}$	W	D	Construction	
2900211	23520 /84622	40	2000	700	4  1x 75 3x 150 3  2x 150 1x 225	148,0



23530 Workbench

Code	No.	mm $\bar{\text{I}}$	W	D	Construction	
2900212	23530 /84622	40	2000	700	4  2x 75 1x 150 1x 225 4  2x 75 1x 150 1x 225	154,0





Workshop Roll Container Series 61

- Solid sheet steel construction, torsionally rigid
- Wheel set 64801, 4 large wheels Ø 125 mm, 2 swivel castors with total brake, load capacity per wheel set 300 kg
- Drawers on telescopic full extension, quick opening, allows fast removal of the drawer by releasing via two levers and if required swapping drawers, load capacity per drawer approx. 40 kg, individually partitionable, front panels with plastic handles and identification strip
- Drawer with individual locking, prevents opening of the drawers when being moved
- Drawer size inside : W 459 x D 510 mm
- Central locking for all drawers using flush installed cylinder locking
- Sturdy handle for moving mounted on the front
- Cover plate from sheet steel, raised edges at all sides, edge protecting profile and internal plastic surface
- In 2 heights 796 mm and 946 mm
- Dimensions: H 796/ 946 x W 541 x D 598/676 mm (incl. handle)
- Standard colour RAL 7035/5010



61655 Height 796



Code	No.	Construction	
2900199	61655	5  3x 75 2x 150	53,0

61875 Height 946



Code	No.	Construction	
2900200	61875	7  5x 75 2x 150	65,0

Drawer dividers in sets

- Suitable for all workbenches and workshop series 230 roll containers series 61
- Consisting of 4 slotted sheets right / left and front / rear and dividers in sheet steel, powder-coated and cross pieces in zinc-plated sheet steel, edges rounded
- Construction in 2 heights 50 mm and 125 mm
- Drawer size inside: 459 x 510 mm



82641-82643 Divider set H 50

- For drawers with 75 mm front panel height

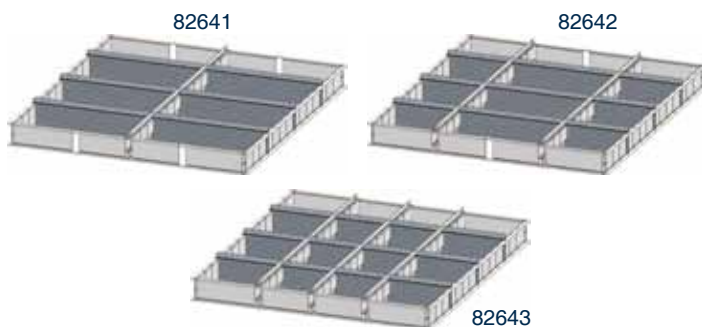

Code	No.	Content	Divided into	
2900201	82641	4 slit plates, 1 divider 6 cross pieces	1/2	1,7
2900202	82642	4 slit plates, 2 dividers, 9 cross pieces	1/3	2,0
2900203	82643	4 slit plates, 3 dividers, 12 cross pieces	1/4	2,4



82644-82646 Divider set H 125

- For drawers with 125 mm front panel height



Code	No.	Content	Divided into	
2900204	82644	4 slit plates, 1 divider 6 cross pieces	1/2	4,0
2900205	82645	4 slit plates, 2 dividers, 9 cross pieces	1/3	4,7
2900206	82646	4 slit plates, 3 dividers, 12 cross pieces	1/4	5,4





Drawer Cabinets Series 550

- Diversity of design options offers wide range of possibilities, optionally 5 - 12 drawers
- For clearly arranged and uncluttered storage
- In sturdy sheet steel construction, with environmentally-friendly electrostatic powder-coating.
- Central locking with cylinder lock and 2 keys
- Drawer size inside: 612 x 612 mm
- Single drawer pull: Using this, we guarantee that only one drawer will open at a time, ensuring the greatest stability and resistance to tilting.
- Handle labelling, replaceable paper and transparent plastic strips in the full-width handle - for keeping tabs on all contents
- Drawer dividers: Slots and perforated bottom make attachment easy
- A great assortment of compartments available.
- Full extension V 150: Capacity up to 100 kg. 100 % drawer extension.
- For best access to tools and small parts
- Normal drawer stop: 80 kg capacity, 90 % of drawer depth opening
- Usable height of the drawer = facing height minus 15 mm
- Standard colour RAL 7016/7035



55120 Drawer cabinet high 800



Code	No.	Construction	
1633457	55120	5  1x 100 4x 150	91,0
1633465	55120 V150	5  1x 100 4x 150	94,0



55130 Drawer cabinet high 800



Code	No.	Construction	
1633473	55130	6  2x 75 1x 100 3x 150	91,0
1633481	55130 V150	6  2x 75 1x 100 3x 150	95,0



55066 Drawer cabinet high 1000



Code	No.	Construction	
9574880	55066	6  1x 75 4x 150 1x 225	106,0
9601719	55066 V150	6  1x 75 4x 150 1x 225	110,0



55076 Drawer cabinet high 1000



Code	No.	Construction	
9510480	55076	7  3x 75 3x 150 1x 225	112,0
9601870	55076 V150	7  3x 75 3x 150 1x 225	116,0





55214 Drawer cabinet hight 1450

Code	No.	Construction	
9585810	55214	14  10x 75 4x 150	176,0
9602840	55214 V150	14  10x 75 4x 150	185,0



55212 Drawer cabinet hight 1450

Code	No.	Construction	
9585730	55212	12  6x 75 6x 150	164,0
9602760	55212 V150	12  6x 75 6x 150	171,0

Drawer Dividers in sets - Series 55

• Dividers in sheet steel, powder-coated • Cross pieces in zinc-plated sheet steel, edges rounded • Drawer size inside: 612 x 612 mm

82907-82915 Divider set H 50

- For drawers with 75/100 mm front panel height
- Drawer size inside: 612 x 612 mm

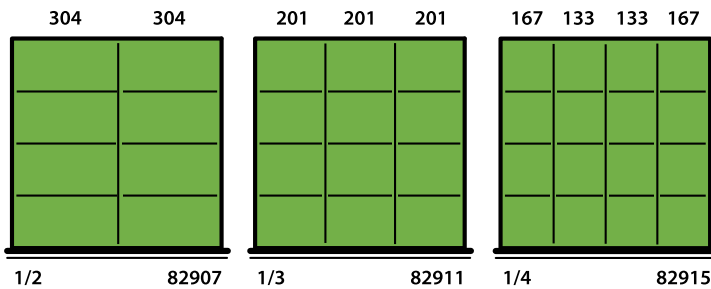

82007-82015 Divider set H 100

- For drawers with 150 mm front panel height
- Drawer size inside: 612 x 612 mm

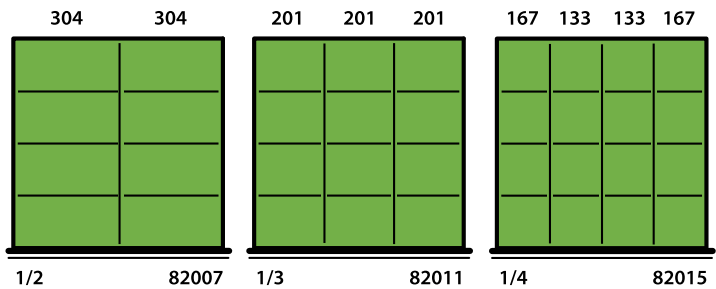

Code	No.	Content	Divided into	
9598630	82907	1 divider, 6 cross pieces	1/2	1,3
9598710	82911	2 dividers, 9 cross pieces	1/3	1,8
9598980	82915	3 dividers, 12 cross pieces	1/4	2,3

Code	No.	Content	Divided into	
9599010	82007	1 divider, 6 cross pieces	1/2	2,6
9599280	82011	2 dividers, 9 cross pieces	1/3	3,7
9599360	82015	3 dividers, 12 cross pieces	1/4	4,6



Drawer Cabinets Series 562





- Central locking with cylinder lock and 2 keys.
- Single drawer pull:
Using this, we guarantee that only one drawer will open at a time.
- Handle labelling
- With slotted walls, perforated bottom, set up for drawer dividers.
- Standard colour RAL 7016/7035

Drawer cabinet height 1000

- With standard or full drawer extension (V 150)
- Dimensions: H 1000 x W 1000 x D 695 mm
- Drawer size inside: 918 x 612 mm
- Full extension V 150: Capacity up to 100 kg.
100 % drawer extension
- Normal drawer stop: 80 kg capacity, 90 % of drawer depth opening
- Usable height of the drawer = facing height minus 15 mm Illustration similar





56207 Drawer cabinet height 1000 with 7 drawers

Code	No.	Picture	Construction	
9586540	56207		7  3x 75 3x 150 1x 225	136,0
9603300	56207 V150		7  3x 75 3x 150 1x 225	140,0

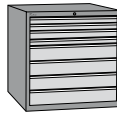

56208 Drawer cabinet height 1000 with 8 drawers

Code	No.	Picture	Construction	
9586620	56208		8  4x 75 4x 150	145,0
9603490	56208 V 150		8  4x 75 4x 150	149,0

Drawer Dividers in sets - Series 562

- Dividers in sheet steel, powder-coated
- Cross pieces in zinc-plated sheet steel, edges rounded
- Drawer size inside: 918 x 612 mm



82561-82563 Divider set H 50

- For drawers with 75/100 mm front panel height
- Drawer size inside: 918 x 612 mm

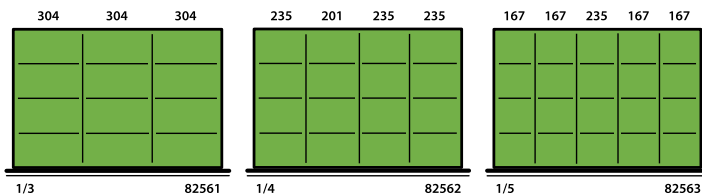



Code	No.	Content	Divided into	
9559810	82561	2 dividers, 9 cross pieces	1/2	2,0
9567400	82562	3 dividers, 12 cross pieces	1/4	2,6
9567590	82563	4 dividers, 15 cross pieces	1/5	3,0

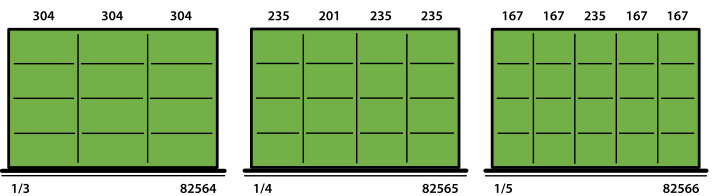

82564-82566 Divider set H 100

- For drawers with 150 mm front panel height
- Drawer size inside: 918 x 612 mm



Code	No.	Content	Divided into	
9567670	82564	2 dividers, 9 cross pieces	1/2	4,4
9567750	82565	3 dividers, 12 cross pieces	1/4	5,4
9638350	82566	4 dividers, 15 cross pieces	1/5	6,4



Drawer Cabinets Series 560

- Central locking with cylinder lock and 2 keys.
- Single drawer pull: Using this, we guarantee that only one drawer will open at a time, ensuring the greatest stability and resistance to tilting.
- Handle labelling, replaceable paper and transparent plastic strips in the full-width handle - for keeping tabs on all contents.
- Drawer dividers
- Slots and perforated bottom make attachment easy.

- Wide variety of dividers.
- Full extension V 150: Capacity up to 100 kg. 100 % drawer extension.
- For best access to tools and small parts.
- Usable height of the drawer = facing height minus 15 mm
- available in two heights with a range, 800 and 1000 mm
- Standard colour RAL 7016/7035

56006-56007 Drawer cabinet height 800

- Drawers on ball bearings with full extension
- Load capacity 100 kg per drawer
- Drawer size inside: 918 x 459 mm
- Dimensions: H 800 x W 1000 x D 535 mm

Code	No.	Construction	kg
1633619	56006	6 2x 75 1x 100 3x 150	96,0
1633627	56007	7 4x 75 1x 100 2x 150	102,0



56050-56090 Drawer cabinet height 1000

- With full extension
- Load capacity 100 kg per drawer
- Drawer size inside: 918 x 459 mm
- Dimensions: H 1000 x W 1000 x D 535 mm



Code	No.	Picture	Construction	kg
9587430	56050		5 3x 150 2x 225	95,0
9587510	56070		7 3x 75 3x 150 1x 225	108,0
9587780	56080		8 5x 75 2x 150 1x 225	115,0
9599440	56090		9 100	118,0

Drawer Dividers in sets - Series 560

- Dividers in sheet steel, powder-coated
- Cross pieces in zinc-plated sheet steel, edges rounded
- Drawer size inside: 918 x 459 mm

82711-82719 Divider set H 50 for drawer cabinets Series 56

- For drawers with 75/100 mm front panel height
- Drawer size inside: 918 x 459 mm

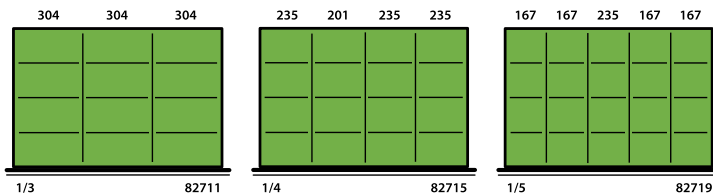

Code	No.	Content	Divided into	kg
9589480	82711	2 dividers, 9 cross pieces	1/2	1,8
9589560	82715	3 dividers, 12 cross pieces	1/4	2,2
9589640	82719	4 dividers, 15 cross pieces	1/5	2,5

82811-82819 Divider set H 100 for drawer cabinets Series 56

- For drawers with 150 mm front panel height
- Drawer size inside: 918 x 459 mm

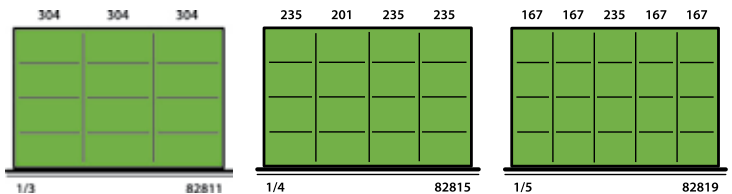

Code	No.	Content	Divided into	kg
9589720	82811	2 dividers, 9 cross pieces	1/2	3,8
9589800	82815	3 dividers, 12 cross pieces	1/4	4,6
9589990	82819	4 dividers, 15 cross pieces	1/5	5,3





Workshop Table Trolleys Series 63

- In welded steel tube, 30 x 30 x 2 mm, load capacity 500 kg
- Wheel set 63801, with 2 swivel castors with brake, 2 fixed castors, load capacity per wheel set 500 kg
- With worktop in multiplex laminated beech wood (1200 x 605 x 25 mm)
- Shelves in multiplex laminated beech wood
- With central locking drawer set or cupboard element (H 470 x W 511 x D 600 mm)
- Drawers rolling stored, partial extension up to approx. 90 %, capacity per drawer 25 kg, with individual locking
- Drawer size inside: 435 x 539 mm
- Dimensions: H 835 x W 1300 x D 605 mm (incl. handle), H 835 x W 1200 x D 605 mm (without handle)
- Standard colour RAL 5010/7035

63000 Workshop table trolley

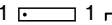

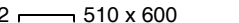

Code	No.	Construction	
9515360	63000	1  1  2  510 x 600	71,0

63000

63110 Workshop table trolley

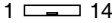



Code	No.	Construction	
9578440	63110	1  140 1  1100 x 600	61,0

63110

63120 Workshop table trolley



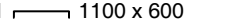



Code	No.	Construction	
9578520	63120	2  140 1  1100 x 600	75,0

63120

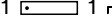
63220 Workshop table trolley







Code	No.	Construction	
9578600	63220	1  1  1  1 	95,0

63220

63230 Workshop table trolley



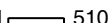

Code	No.	Construction	
9578790	63230	1  1  1  140 1  510 x 600	83,0

63230

63300 Workshop table trolley



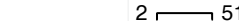

Code	No.	Construction	
9578870	63300	4  90 2  510 x 600	85,0

63300

63330 Workshop table trolley



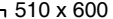

Code	No.	Construction	
9578950	63330	4  90 1  140 1  510 x 600	97,0

63330





63320 Workshop table trolley



63320

Code	No.	Construction	
9579170	63320	4  90 4  90	121,0

63340 Workshop table trolley

Code	No.	Construction	
9579090	63340	4  90 1  1 	92,0



63340

82631-82633 Divider set H 50

- Only for drawer size inside: W 435 x D 539 mm
- Cross pieces in zinc-plated sheet steel, edges rounded
- Front panel height 90 mm
- Dividers in sheet steel, powder-coated

Code	No.	Content	Divided into	
9638440	82631	1 divider, 6 cross pieces	1/2	0,9
9638520	82632	2 dividers, 9 cross pieces	1/3	1,3
9638600	82633	3 dividers, 12 cross pieces	1/4	1,8

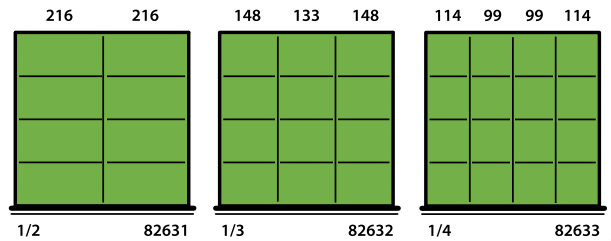



Trough Trolleys Series 63



- In welded steel tube, 30 x 30 x 2 mm
- Wheel set 63801, 2 swivel castors with brake, 2 fixed castors, solid-rubber tyres 200 x 50 mm
- Each trough to support approx. 70 kg, evenly distributed
- Trough size: outside 1200 x 600 mm, inside: 1021 x 596 mm
- With sheet steel top, edge 35 mm, welded, edges rounded off for protection
- Dimensions: H 805 x W 1240 x D 600 mm (incl. handle), H 805 x W 1200 x D 600 mm (without handle)
- Standard colour RAL 5010

63020 Trough Trolley with 2 troughs



Code	No.	Construction	
9578280	63020	2  1200 x 600	42,0

63030 Trough Trolley with 3 troughs

Code	No.	Construction	
9578360	63030	3  1200 x 600	53,0







Mobile Workbenches Series 66

- The robust mobile workplace in varying designs
- Strong construction in high-quality sheet steel
- Varying drawer heights may be combined in the drawer block
- Drawers with individual locking and central locking system
- Drawers on roller bearings, 25 kg load capacity, individual locking
- Lockable door
- Shelf, zinc-plated, variably adjustable, locked in position by plastic rivet
- Benchtop in solid beech, glued crosswise for rigidity
- Fitted with large, tubular push handle, optionally installed on the left or the right
- Central locking - locks drawer and doors
- On sturdy low-friction wheels fitted with double wheel brake
- Wheel set 64803, two fixed and two swivel castors with total brake, Ø 125 mm, load capacity per wheel set 450 kg
- Dimensions: H 925 x W 1310 x D 605 mm (incl. handle), H 925 x W 1200 x D 605 mm (without handle)
- Benchtop dimensions: W 1200 x H 25 x D 605 mm
- Drawer size inside:
W 999 x D 539 mm (wide drawer)
W 459 x D 539 mm (small drawer)
- Standard colour RAL 3003/3003



66040 Mobile workbench



Code	No.	Construction	
9570970	66040	5  2x 90 2x 135 1x 180 1 	107,0

66061 Mobile workbench



Code	No.	Construction	
9511370	66061	5  2x 90 2x 135 1x 180 1 	111,0

58660 Shelf for Workbenches Series 23 & 66

- In zinc-plated sheet steel with folded edges for safety
- Height adjustable
- including attachment material (mounting bracket)



Code	No.	B	T	
1481142	58660	480	550	2,5

Drawer Dividers in sets

- Dividers in sheet steel, powder-coated
- Cross pieces in zinc-plated sheet steel, edges rounded
- Drawer size inside: 459 x 539 mm

82107-82115 Divider Set H 50

- For drawers with 90 mm front panel height

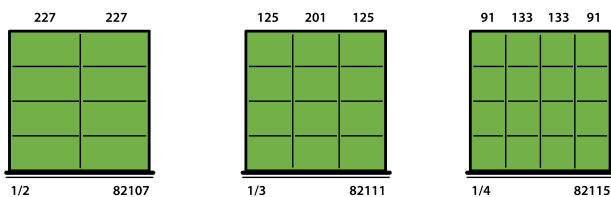

Code	No.	Content	Divided into	
9581820	82107	1 divider, 6 cross pieces	1/2	1,0
9581900	82111	2 dividers, 9 cross pieces	1/3	1,5
9582040	82115	3 dividers, 12 cross pieces	1/4	1,8

82207-82215 Divider Set H 100

- For drawers with 135/180 mm front panel height

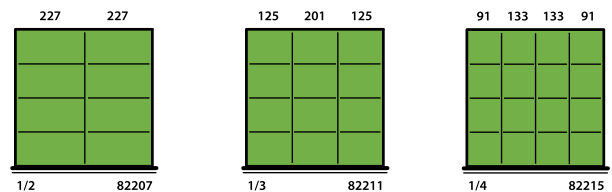

Code	No.	Content	Divided into	
9582120	82207	1 divider, 6 cross pieces	1/2	2,0
9582200	82211	2 dividers, 9 cross pieces	1/3	2,9
9582390	82215	3 dividers, 12 cross pieces	1/4	3,8



Workshop Trolley - The Sturdy Middle Class Series 60

- Solid sheet steel construction, torsionally rigid
- Wheel set 60801, 4 large wheels, 2 swivel castors Ø 100 mm, 1 with brake, 2 fixed castors Ø 140 mm, laterally protruding, therefore high stability, load capacity per wheel set 210 kg
- Drawers with telescopic full extension and individual locking device, load capacity 25 kg per drawer, variable torsionally central locking with cylinder lock, supplied with 2 keys
- Drawers with individual locking with practical one-hand operation system, prevents opening of the drawers when being moved
- Worktop in ABS with recesses for small parts, convenient storage option, prevents working material from rolling away
- Side walls with square perforation to take various METEC accessories
- Dimensions: H 930 x W 720 x D 410 mm (incl. handle), H 930 x W 630 x D 410 mm (without handle)
- Drawer size inside: 482 x 345 mm
- Standard colour RAL 3003/7016

60050-60070 Workshop trolley







60050



60060



60070

Code	No.	Construction	 kg
1633732	60050	5  2x 75 2x 150 1x 225	45,0
1549227	60060	6  3x 75 3x 150	48,0
1549235	60070	7  5x 75 2x 150	49,0

65113 Lengthwise divider for drawers



- In zinc-plated sheet steel





60044 Tool chest for Series 60

- Drawers with telescopic full extension, individual locking of each drawer over practical single-hand-system, load capacity of the drawer 25 kg
- Worktop from ABS with deep-drawn recesses for small parts
- Central locking with cylinder lock
- Practical carrying handles on either side
- Side panels with perforation
- Dimensions: H 403 x W 630 x D 410 mm
- Standard color RAL 3003/7016



Code	No.	 H	< mm >	 kg
9592780	65113	50	343	140

Code	No.	Construction	 kg
1633716	60044	4  75	28,0







Large-Capacity Workshop Trolleys Series 64

- Heavy sheet steel type with sturdy base, very warp-resistant and for high loadings
- Wheel set 64803 with 2 wheels Ø 125 mm, 2 swivel castors with total brake, load capacity per wheel set 450 kg
- Drawers on telescopic full extension, quick opening, allows fast removal of the drawer by releasing via two levers and if required swapping drawers
- Load capacity 35 kg per drawer
- Drawers with individual locking with practical one-hand operation system, prevents opening of the drawers when being moved
- Drawer size inside: 575 x 410 mm
- Central locking for all drawers using flush installed cylinder locking
- Rear side with buffer
- Worktop in ABS with deep-drawn working surface and recesses for small parts, convenient storage option, prevents working material from rolling away
- Rear wall with square perforation
- Dimensions: H 940 x W 780 x D 490 mm (incl. handle), H 940 x W 700 x D 490 mm (without handle)
- Standard colour RAL 7016/3003





64064-64084 Workshop trolley H 940

Code	No.	Construction	
9570460	64064	6  3x 75 3x 150	68,0
9558330	64074	7  5x 75 2x 150	72,0
9570700	64084	8  7x 75 1x 150	76,0

64044 Tool chest

- For use with all workshop trolleys
- With practical, fully-recessed carrying handles
- Roomy storage compartment
- With 4 drawers, front panel height 75 mm
- Dimensions: H 495 x W 700 x D 490 mm

Code	No.	Construction	
9593910	64044	4  75	44,0



82511-82519 Divider set H 50 for workshop trolleys Series 64

- For drawers with 75 mm front panel height
- Drawer size inside: 575 x 410 mm

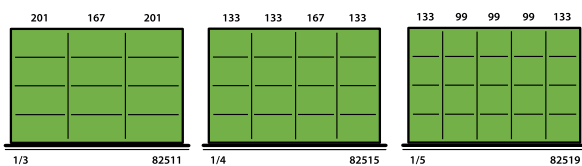

Code	No.	Content	Divided into	
9594480	82511	2 dividers, 9 cross pieces	1/3	1,3
9594560	82515	3 dividers, 12 cross pieces	1/4	1,7
9594640	82519	4 dividers, 15 cross pieces	1/5	2,0

82611-82619 Divider set H 100 for workshop trolleys Series 64

- For drawers with 150 mm front panel height
- Drawer size inside: 575 x 410 mm

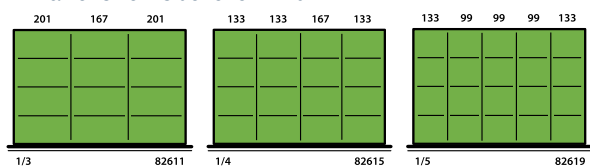

Code	No.	Content	Divided into	
9594720	82611	2 dividers, 9 cross pieces	1/3	2,2
9594800	82615	3 dividers, 12 cross pieces	1/4	3,2
9594990	82619	4 dividers, 15 cross pieces	1/5	3,8







Workshop Trolley - The Roomy Middle Class Series 67

- The universal solution for our workplate
- Solid sheet steel construction, torsionally rigid
- Wheel set 64801, 4 large wheels Ø 125 mm, 2 swivel castors with total brake, load capacity 300 kg
- Drawers with 100 % extension, load capacity 25 kg
- Drawers on telescopic full extension, quick opening, allows fast removal of the drawer by releasing via two levers and if required swapping drawers
- Drawers with individual locking with practical one-hand operation system, prevents opening of the drawers when being moved
- Central locking of all drawers by cylinder lock
- Worktop in ABS with recesses for small parts, convenient storage option, prevents working material from rolling away
- Rear wall and side walls with square perforation
- Impact protection on the rear wall edges
- Dimensions: H 930 x W 775 x D 470 mm (incl. handle), H 930 x W 700 x D 470 mm (without handle)
- Drawer size inside: W 570 x D 340 mm
- Standard colour RAL 3003/3003





67054-67074 Workshop trolley

Code	No.	Construction	 kg
9511450	67054	5  3 x 75 1x 150 1x 225	56,0
9511530	67064	6  4 x 75 2x 150	59,0
9511610	67074	7  6 x 75 1x 150	61,0

67220 Lectern worktop

- For combining with tool trolleys of the series 67
- Drawers fitted with individual locking
- Rear wall with square perforation
- Writing surface from black plastic
- Not lockable
- Dimensions: H 283/183 x W 696 x D 470 mm
- RAL 3003/3003





Code	No.	Construction	 kg
2337673	67220	1  75	17,0

67043 Tool chest

- For combining with tool trolleys of the series 67
- Drawers fitted with individual locking
- Rear wall and side walls with square perforation
- Worktop from ABS with deep-drawn recesses for small parts
- Central locking with cylinder lock
- Dimensions: H 410 x W 700 x D 470 mm
- RAL 3003/3003



Code	No.	Construction	 kg
9552990	67043	3  75	26,0

65400-65410 Storage tray for workshop trolley 67064

- No. 65400 for lateral fitting
- No. 65410 for fitting on the back
- RAL 7016





Code	No.	RAL	H	W	D	 g
1823019	65400	7016	60	90	308	800
1823027	65410	7016	60	90	437	1040

65114-65115 Lengthwise divider for drawers

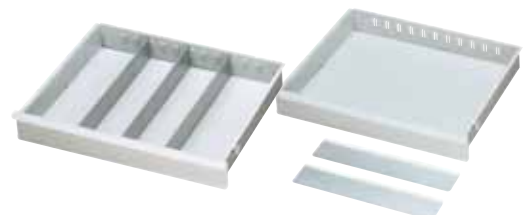
- For all models of the serie 67 & serie Major





Code	No.	 H	< mm >	 g
9552640	65114	50	339	130
9552720	65115	100	339	260

66070 Mobile workbench

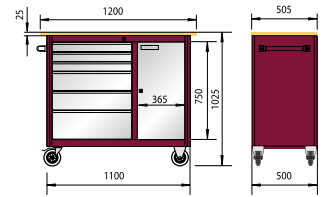
- Drawers with telescopic full extension, load capacity 25 kg
- Drawer size inside: W 570 x D 340 mm
- Drawers with individual locking with single-hand operation Individual locking device to prevent more than one drawer being opened at a time
- Central locking
- Right hand side with lockable door
- Rear wall partly with square perforation to take accessories
- Large push handle
- Multiplex laminated beech wood worktop (W 1150 x H 505 x D 25 mm)
- Dimensions: H 1025 x W 1205 x D 505 (incl. handle), H 1025 x W 1150 x D 505 mm (without handle)
- Standard colour RAL 3003/3003



Code	No.	Construction	H	W	D	
2341794	66070	6  3x 75 2x 150 1x 225 1 	1025	1150	505	92





Workshop trolley - Series Major

- Solid sheet steel construction, fully welded
- Wheel set 64801, 4 large wheels Ø 125 mm, 2 swivel castors with total brake, load capacity 300 kg
- Drawers with 100 % full extension, load capacity 25 kg
- Drawers on telescopic full extension, quick opening, allows fast removal of the drawer by releasing via two levers and if required swapping drawers
- Drawers with individual locking with practical one-hand operation system, prevents opening of the drawers when being moved
- Central locking of all Drawers by cylinder lock
- Worktop in ABS, deep drawn, prevents working material from rolling away
- Side punching for paper roll holder, trash cans and storage compartment
- Drawer size inside: W 569 x D 339 mm
- Standard colour RAL 3003/7016

67471 Workshop trolley Major

- Dimensions: H 921 x W 787 x D 430 mm (incl. handle), H 921 x W 709 x D 430 mm (without handle)
- Standard colour RAL 3003/7016





Other models on request.

Code	No.	Construction	
2900170	67471	7  6x 75 1x 225	55,0



67556 Workshop trolley Major XL

- Left side with drawers, telescopic full extension with quick opening
- Right door-fold with 1 shelf
- Dimensions: H 921 x W 1136 x D 430 mm (incl. handle), H 921 x W 1061 x D 430 mm (without handle)
- Standard colour RAL 3003/7016



Code	No.	Construction	
2900221	67556	7  5x 75 2x 150 1  1 	72,0







67526 Workshop trolley Major XL

- Left side with drawers, telescopic full extension with quick opening
- Right side with vertically drawers with shelf for up to 12 cans with a Ø to 78 mm and a height of 215 mm
- Dimensions: H 921 x W 1136 x D 430 mm (incl. handle), H 921 x W 1061 x D 430 mm (without handle)
- Standard colour RAL 3003/7016

Code	No.	Construction	
2900220	67526	7  5x 75 2x 150 1  with canshelf for up to 12 pieces	75,0

67536 Workshop trolley Major XL

- Left side with drawers, telescopic full extension with quick opening
- Right side with vertically drawers with perforated sheet can be filled on both sides
- With tool holders and hook to 30 kg implements,
- Dimensions: H 921 x W 1136 x D 430 mm (incl. handle), H 921 x W 1061 x D 430 mm (ohne Griff)

Code	No.	Construction	
2900171	67536	7  5x 75 2x 150 1  with perforated plate	76,0





67405 Perforated panel for workshop trolley Major & Major XL

- For lateral fitting for working material optionally installed on the left, on the right or both sides
- Standard colour RAL 3003/7016

Code	No.	
2830906	67405	2,5

84322-84323 Laminated beech wood worktop to insert

- Will not crack or warp
- Four-ply glued wood, clear varnished

Code	No.	For model	mm 	
2838931	84322	MaJor	25	5,0
2838907	84323	MaJor XL	25	8,0





Accessories

- Easy expansion of storage space or optimisation of the storage area through extensive and practical accessory range
- For all workshop trolleys with perforated panels
- Accessory attachment parts can be hooked in or screwed on



65205 Paper roll holder

- For paper rolls up to Ø 300 mm, tube diameter 20 mm

Code	No.	
9512260	65205	1,6



65206 Storage tray

Code	No.	H	W	D	
9592940	65206	60	210	85	0,5



65208 Storage tray for cans

- With practical carryind handles
- Incl. divider set for up to 8 cans

Code	No.	H	W	D	
1398482	65208	100	300	160	2,5



65209 Waste basket

Code	No.	H	W	D	
9512340	65209	300	300	160	3,5





Workshop trolley - alu

- Central locking with cylinder lock
- Covering - removable aluminium tray with rim on all sides to prevent small parts rolling away and store them securely, easy to clean
- Drawers with single drawer pull, only one drawer can be opened at a time, ensuring absolute tilt resistance when moving
- Max. drawer load 20 kg
- Drawer size inside: W 482 x D 345 mm
- Carcase made of aluminium 100% corrosion resistant, 2/3 weight savings compared to classical sheet steel construction
- Absolutely food safe
- Resistant to salt water
- Tyres suitable for temperature ranges from -20 °C to +80 °C
- 4 large wheels, wheel fork made of stainless steel, 2 fixed and 2 braked swivel castors, Ø 100mm
- Load 420 kg per wheel set
- Sturdy handle for moving made of anodised aluminium with decorative upper handle band
- Dimensions: H 1000 x W 613 x D 445 mm (without handle), H 1020 x W 687 x D 445 mm (incl. handle)

10 Workshop trolley alu



Code	No.	Construction	 kg
1851772	1060070	7  4x 75 3x 150	38,0

10 Tool chest for workshop trolleys alu

- Dimensions: H 408,5 x W 616 x D 445 mm

Code	No.	Construction	 kg
1852272	1060044	4  4x 75	18,0



Workshop trolley alu also in ESD protected construction available. More information upon request.



QM-Mobile

- A mobile test bed for process monitoring site
- 2 constructions: open version, closed version
- Large-area writing and working desk at standing height, panel inclination 12°, plastic writing board with circumferential edge protection
- 1 drawer, blend height 75 mm, telescopic full extension, load capacity 25 kg, single drawer lock, which prevents opening while driving, lockable with cylinderlock
- Drawer size inside: W 570 x D 340 mm, variable along divisible
- Wheel 64801, 4 large wheels Ø 125 mm, 2 castors with brake, maximum load 300 kg
- Lateral push handle, installed on the right or the left
- Dimensions: W 696/ 775 (incl. handle) x D 470 x H 1207 mm
- Open Construction:
 - Center and bottom each have a shelf, not adjustable, for storing documents folders and accommodation of measuring and control devices
- Closed Construction:
 - Centered 1 shelf, not adjustable, front large door locked separately with cylinder lock
- Standard colour RAL 3003/3003







69250 Construction open

Code	No.	H	W	D	Construction	 kg
2900197	69250	1207	696	470	1  75 2 	36,0



69260 Construction closed

Code	No.	H	W	D	Construction	 kg
2900198	69260	1207	696	470	1  75 1  1 	40,0





Computer Cabinets Series 69

- For the optimum housing of computers employed in the workshop area
- Featuring 3 compartments, for monitor, keyboard, and tower/desktop
- With upper compartment incorporating a hinged door with plastic window (acrylic-glass) to protect the monitor
- With pull-out drawer for the keyboard, with fold-down front panel, drawer on roller-bearing rails to take 35 kg loading
- Lower cabinet fitted with 2 swing doors with ventilation openings and height adjustable shelf
- Lockable with 3 cylinder locks taking the same key, supplied with 3 keys
- Dimensions: H 1710 x W 720 x D 600 mm
- Equipment: 1 input socket, 6 installed safety outlets, micro-fuse 6A, ON/OFF switch, installed fan with filter for ventilation
- With wheel set 69801 consisting of 2 each swivel and fixed castors with brake. Load capacity per wheel set 300 kg
- Delivery without decoration
- Standard colour RAL 7035/5010

69410-69420 Computer cabinet



69450 Computer desk installation

- Set up for desktop computer
- Fitted with a bracket for wall installation on the rear face
- Dimensions: H 930 x W 720 x D 600 mm



Code	No.	
1482114	69450	56,0

Code	No.	Description	
9512420	69410	Computer cabinet with wheel set	90,0
9512690	69420	Computer cabinet with wheel set	86,0

69350 Computer cabinet for flat screens

- Specially suited for accommodating flat screens in the workshop, production or warehouse areas
- Upper area with separately lockable compartment for monitor (flat screen max. up to 20 inch)
- Large storage and writing area, sliding keyboard shelf in the centre
- Lower cupboard area with a double door with ventilation openings and a height adjustable shelf
- Lockable via 3 point lock by means of turning handle with cylinder lock, locks both door and sliding keyboard shelf
- Sturdy steel tube handle on the side
- Mobile, wheel set 69801, two fixed and two swivel castors with brake, traceless grey, load capacity 300 kg
- Dimensions: H 1625 x W 700 x D 600 mm
- Electrical fittings:
 - 1 input socket
 - 3 installed safety outlets 230 V
 - Micro-fuse 3, 15 A
 - ON/OFF switch
 - Installed fan with filter for ventilation
- Delivery without decoration



Code	No.	RAL	
1949314	69350	7035/5010	69,0







Lockers with hinged doors with view Series 52

- In high-quality sheet steel, welded, with reinforced doors and 3-point-safety locking
- Height adjustable shelves in zinc-plated sheet steel, load capacity per shelf approx. 50 kg
- Drawers on rollers, load capacity per drawer 25 kg, front panel height 83 mm
- Drawer size inside: small drawer 396 x 390 mm, wide drawer 806 x 390 mm
- Standard colour RAL 7035/5010

52110-52120 Locker with hinged doors 3-point-locking

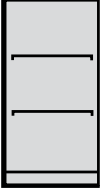

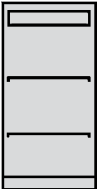
- Dimensions: W 516 x H 1000 x D 500 mm, compartment size W 491 x D 470 mm
- Drawer size inside: W 396 x D 390 mm





Code	No.	Illustration	Construction	 kg
2140551	52110		2 	31,0
2341050	52120		2  1 	35,0



52130-52140 Locker with hinged doors 3-point-locking

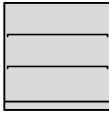

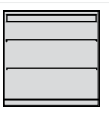
- Dimensions: W 950 x H 1000 x D 500 mm, compartment size W 925 x D 450 mm
- Drawer size inside: W 806 x D 390 mm

Code	No.	Illustration	Construction	 kg
2178400	52130		2 	46,0
2146231	52140		2  1 	53,0





52140



52160 Locker with hinged doors

- With 4 shelves
- Dimensions: H 1900 x W 516 x D 500 mm
- Compartment size: W 491 x D 470 mm



Code	No.	Construction	 kg
2271613	52160	4  491 x 470	58,0







52240-52260 Locker with hinged doors

- Dimensions: H 1900 x W 950 x D 400/600 mm

Code	No.	Construction	T	
2135191	52240	4  925 x 350	400	76,0
2174286	52260	4  925 x 550	600	94,0

52520 Locker with hinged doors with safe deposit box



- Safe deposit box with safety lock, approx. 350 mm high and 400 mm deep, with 3 height adjustable shelves
- Dimensions: H 1900 x W 950 x D 500 mm, Compartments size: W 925 x D 450 mm

Code	No.	Construction	
2153467	52520	3  925 x 450	89,0





52510 Universal locker

- With central divider, full-width hat shelf, 4 height adjustable shelves on left, clothes rail on right
- Dimensions: H 1900 x W 950 x D 500 mm,

Code	No.	Construction	
2233371	52510	4  450 x 450 1 	91,0

52200 Locker with hinged doors 3-point-locking

- Dimensions: H 1900 x W 950 x D 500 mm, Compartment size: W 925 x D 450 mm



Code	No.	Construction	
2090759	52200	4  925 x 450	83,0





52600 System locker

- With central divider, safe deposit box with safety lock on left
- 15 drawers on roller, drawer front panel height 83 mm, 25 kg loading per drawer
- Drawer size inside: W 360 x D 390 mm
- 4 height adjustable shelves on right, capacity 50 kg per shelf
- Dimensions: W 950 x H 1900 x D 500 mm, compartment size W 450 x D 450 mm

Code	No.	Construction	
2202972	52600	15  4  450 x 450	162,0

Lockers with hinged doors with view Series 52



- Doors with acrylic-glass provide transparency and insight into the cabinets as well as quick access without a long search

- Standard colour RAL 7035/5010



52135 Locker with hinged doors



- Dimensions: W 925 x H 1000 x D 500 mm

Code	No.	Construction	
1634704	52135	2  925 x 450	45,0



52269 Locker with hinged doors

- Dimensioins: W 950 x H 1900 x D 500 mm

Code	No.	Construction	D	
1480960	52269	4  925 x 450	500	78,0



58010-58050 Shelf

Code	No.	Application	W	D	
9575770	58010	52600	450	450	2,0
9575850	58020	52200	925	450	4,0
9591110	58030	52240	925	350	3,2
9599950	58040	52110,52160	491	470	2,3
9600980	58050	52260	925	550	4,7

Divider set

82521-82523 Divider set H 50 for supboards series 52

- Drawer size inside: **W 360 x D 390 mm**
- For drawer with front panel height 83 mm

Code	No.	Content	Divided into	
9558920	82521	1 divider, 6 cross pieces	1/2	0,8
9559060	82522	2 dividers, 9 cross pieces	1/3	1,0
9559140	82523	3 dividers, 12 cross pieces	1/4	1,4

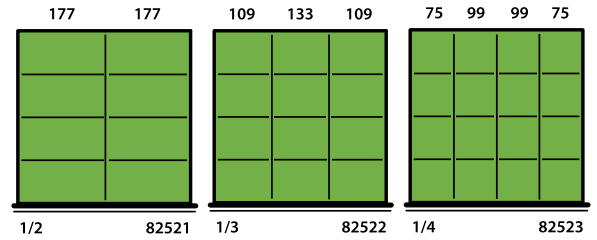

82524-82526 Divider set H 50 for supboards series 52

- Drawer size inside: **W 396 x D 390 mm**
- For drawer with front panel height 83 mm

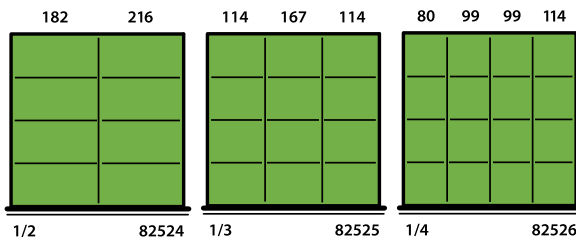

Code	No.	Content	Divided into	
9559220	82524	1 divider, 6 cross pieces	1/2	0,8
9559300	82525	2 dividers, 9 cross pieces	1/3	1,1
9559490	82526	3 dividers, 12 cross pieces	1/4	1,5

82527-82529 Divider set H 50 for supboards series 52

- Drawer size inside: **W 806 x D 390 mm**
- For drawer with front panel height 83 mm

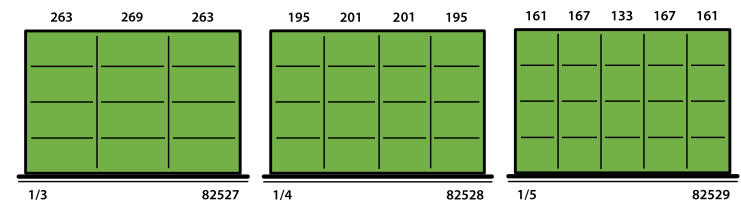

Code	No.	Content	Divided into	
9559570	82527	2 dividers, 9 cross pieces	1/3	1,6
9559650	82528	3 dividers, 12 cross pieces	1/4	1,9
9559730	82529	4 dividers, 15 cross pieces	1/5	2,2

Environment Safety Cabinets Series 52



- Connect safety and functionality
- For secure storage of non-flammable, water-polluting substances in original containers
- Protection against discharge damage by chemicals
- For quality sheet steel, fully welded, powder-coated
- With reinforced doors and 3-locked safety lock, tuning handle with cylinder lock

- Interior with 4 tray shelves made of plastic with perforated plastic inserts (PE), according to DIN 16776, height adjustable in increments of 40 mm
- Load capacity per shelf max. 70 kg
- Collection capacity per shelf, large max. 20 liters
- Collection capacity per shelf, small max. 10 liters
- Vent holes at the bottom of the doors and in the upper part
- RAL 7035/7035

52710 Environment safety cabinet B 950

- With reinforced doors
- Shelves size inside: W 919 x D 447 mm
- Collecting shelv with a capacity of 20 litres
- Dimensions: W 950 x H 1900 x D 500 mm





Code	No.	Construction	W	H	D	
1823043	52710	4 	950	1900	500	90,0
			922 x 450			

52720 Environment safety cabinet B 516

- With reinforced doors
- Shelves size inside: W 483 x D 467 mm
- Collecting shelv with a capacity of 10 litres
- Dimensions: W 516 x H 1900 x D 500 mm



Code	No.	Construction	W	H	D	
1823051	52720	4 	516	1900	500	56,0
			486 x 470			



Clothes Lockers Series 53

- Basic equipment: Base, reinforced doors, separately lockable with latch, ventilating holes top and bottom
- Compartments with hat shelf, clothes rail, three sliding clothes hooks, towel holder

- Compartment width: 300 mm, depth: 500 mm
- Standard colour RAL 7035/7035



53012-53072 Clothes locker





- Dimensions: H 1850 x D 500 mm,

Code	No.	Compartments	W	
9520010	53012	1	300	31,0
9520360	53032	2	600	54,0
9520790	53072	3	900	73,0



53412-53472 Clothes locker

- Two-storey
- Dimensions: H 1850 x D 500 mm,
- Compartment size: H 800 x W 250 x D 480 mm

Code	No.	Compartments	W	
9526720	53412	2 	300	33,0
9596770	53432	4 	600	56,0
9596850	53472	6 	900	80,0



53102-53122 Clothes locker with seat bench

- Dimensions: H 2100 x D 500 mm
- Seat bench: H 400 x D 300 mm

Code	No.	Compartments	W	
9521090	53102	2	600	57,0
9521250	53122	3	900	93,0

53302 Locker for cleaning materials

- Doors flush inset
- 4 shelves on left, hat shelf on right, clothes rail, clothes hooks, towel holder
- Dimensions: H 1850 x D 500 mm

Code	No.	Compartments	W	
9576310	53302	4 	600	60,0





Seat benches Series 54

- Frame and feet in square tubing, 30 x 30 x 2 mm
- Seating depth 330 mm, seat height 400 mm
- Hardwood slats, in natural varnish
- Standard colour RAL 7016

54003-54203 Changing cubicle seat bench

- Feet with plastic gliders
- Height 400 mm

Code	No.	Construction	< mm >	
9576580	54003	with 2 feet in square	900	8,0
9576660	54103	with 3 feet in square	1500	12,0
9576740	54203	with 3 feet in square	2000	15,0



Wall cabinets Series 58

- Rear wall with square perforation, 10 x 10 mm, distance centre-to-centre 38 mm
- For the safe and visible storage of tools and small parts
- In sturdy sheet steel construction, with safety cylinder lock
- Easy-to-use hanging system, set up to fast repositioning when required
- Door hinged optionally right or left
- Dimensions: H 750 x D 200 mm
- Shelves height-adjustable
- Standard colour RAL 7035/5010

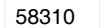
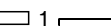
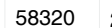
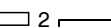
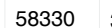
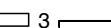

58310-85330 Tool cabinet

Code	No.	Construction	W	
1481118	58310	1  1 	500	14,0
1481126	58320	2  2 	1000	22,0
1481134	58330	3  3 	1500	39,0



58310



58320





58330

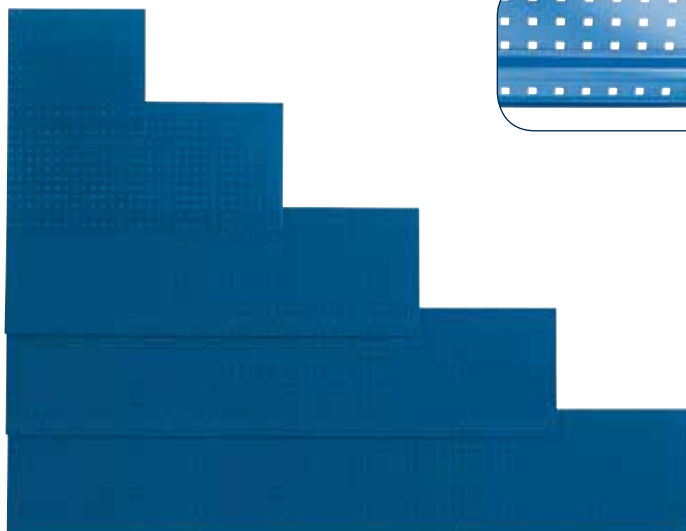
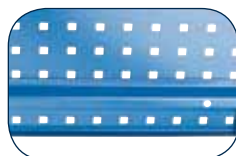

71000-71030 Perforated panel with square perforation

- Versatile and practical
- In various dimensions
- Strong Construction with welded-on reinforcements, edges rounded off on all sides
- With symmetrical perforation, perforation squares 10 x 10 mm, distance centre-to-centre 38 mm vertically and horizontally
- Special hooks and clips for simple insertion with locking pin
- For practical and secure holding of complex and heavy parts
- Standard colour RAL 5010



Code	No.	H	W	
2132028	71000	494	494	3,0
2126559	71010	494	988	6,0
2127318	71011	494	1178	7,0
2127326	71020	494	1482	8,0
2126494	71030	494	1976	12,0



Tool Holders / Tool Hooks to clip



82820-82835 Tool hook
straight mandrel

Code	No.	< mm >	Ø	
1481274	82820	50	6	34
1481428	82834	102	6	46
1481436	82835	150	6	56



82841-82843 Tool hook
double, straight mandrel

Code	No.	< mm >	Ø	
1481495	82841	50	6	74
1481509	82842	102	6	98
1481517	82843	150	6	118



82821-82830 Tool hook
inclined hook end

Code	No.	< mm >	Ø	
1481282	82821	50	6	34
1481347	82828	100	6	46
1481355	82829	150	6	56
1481363	82830	200	6	68



82836 Inclined holder
for sockets

Code	No.	L ₁	L ₂	Ø	
1481444	82836	15	40	6	34



82831-82833 Tool hook
vertical hook end

Code	No.	< mm >	Ø	
1481371	82831	35	6	34
1481398	82832	70	6	46
1481401	82833	135	6	56



82837-82840 Tool holder
double,
vertical hook end

Code	No.	< mm >	Ø	
1481452	82837	35	6	76
1481460	82838	50	6	80
1481479	82839	75	6	90
1481487	82840	150	6	98

82873-82874 Tool holder



Code	No.	Construc- tion	W	L	Ø	
1481835	82873	3-tray	45	150	6	170
1481843	82874	6-tray	240	140	6	256



82822-82849 Tool clamp
simple

Code	No.	Ø	
1481568	82847	6	24
1481290	82822	10	25
1481576	82848	13	26
1481584	82849	16	27
1481304	82823	19	28



82844-82846 Tool clamp
large baseplate

Code	No.	Ø	
1481525	82844	25	58
1481533	82845	28	60
1481541	82846	32	64



82869 Holder for round stock

Code	No.	W	L	
1481797	82869	27	65	68



82851-82855 Tool clamp
double

Code	No.	Ø	
1481592	82851	6	54
1481606	82852	10	54
1481614	82853	13	58
1481622	82854	16	58
1481630	82855	19	60



82875-82877 Machine holder

Code	No.	Ø	
1481851	82875	40	68
1481878	82876	60	72
1481886	82877	80	80



82870-80872 Pliers holder

Code	No.	W	D	
1481800	82870	35	20	62
1481819	82871	55	20	66
1481827	82872	75	20	68



82882-82883 Tube holder

Code	No.	W	Ø	
1481916	82882	35	60	114
1481924	82883	35	100	156



82878 Saw holder

- for 4 saws
- Please order in pairs!

Code	No.	D	H	
1481894	82878	80	52	86



82824 Spanner holder

• for 8 spanners

Code	No.	D	W	
1481312	82824	137	124	220



82825 Spanner holder

• for 10 spanners

Code	No.	H	W	
1481320	82825	227	57-147	480

82886-82887 Screwdriver holder

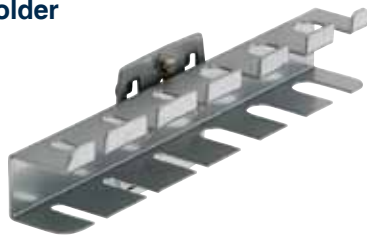

Code	No.	Construction	W	D	
1481959	82886	for 6 pieces	200	30	200
1481967	82887	for 12 pieces	390	30	400

82888-82889 Drill-bit holder

• **82888** with 14 holes
 Ø 2 ea. 3,0 4,2 6,5
 7,5 8,5 16,5 mm,
 1 ea. 10,5 12,5 mm

• **82889** with 28 holes
 Ø 4 ea. 3,2 4,2 6,5
 7,5 8,5 16,5 mm,
 2 ea. 10,5 12,5 mm



Code	No.	W	D	
1481975	82888	200	28	200
1481983	82889	390	28	400

82885 Holder for allen keys

Code	No.	W	H	
1481940	82885	200	73	300

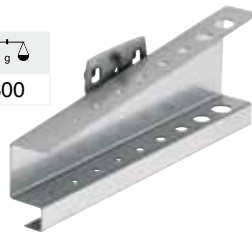

82884 Bit holder

Code	No.	W	H	
1481952	82884	150	35	200



82827 Socket holder support with 12 holes



Code	No.	W	H	
1481339	82827	390	30	500

82861 Tool holder

• for customising



Code	No.	W	H	D	
1481703	82861	340	55	135	1100

82858 Combination holder 2 pieces

Code	No.	W	L	
1481655	82858	55	150	400



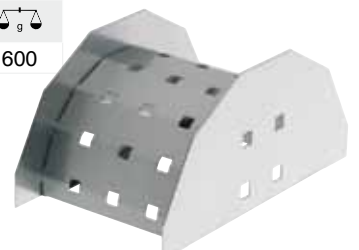

82864 Hose holder

Code	No.	W	D	
1481762	82864	230	125	600

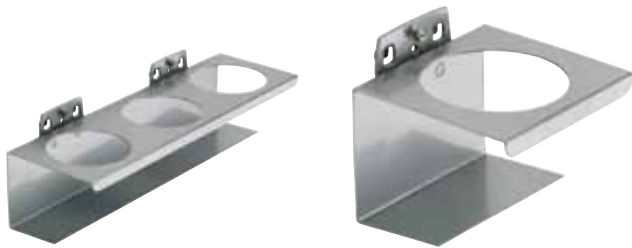

82859-82860 Tool holder for round cans



Code	No.	Construction	Ø	W	
1481673	82859	1-tray	70	100	200
1481681	82860	3-tray	70	300	600

82862-82863 Support plate



Code	No.	W	D	
1481746	82862	350	125	600
1481754	82863	445	150	900

82856-82857 Base plate



Code	No.	Construction	
1481649	82856	small	20
1481657	82857	large	40

82893 Carrier trail for perforated panels with 10x10 mm square holes

- for open storage boxes



Code	No.	H	W	
1955608	82893	495	60	418

82867 Hook assortment 18 pieces

Consisting of:

- Tool holder, inclined hook end, 5 pieces No. 82821 L= 50 mm
- Tool holder, straight mandrel, 2 pieces No. 82832 L= 70 mm
- Tool holder, double, straight mandrel: 2 pieces No. 82837 L= 35 mm, 1 piece No. 82838 L= 50 mm
- Tool clip, simple: 2 pieces No. 82822 Ø 10 mm, 1 piece No. 82848 Ø 13 mm
- Pliers holder 2 pieces No. 82871 W= 55 mm
- Spanner holder for 8 spanners, 1 piece No. 82824
- Screwdriver holder for 6 screwdrivers, 1 piece
- Drill-bit holder, for 14 drills, 1 piece No. 82886
- Colour alu

Code	No.	
1481770	82867	1400

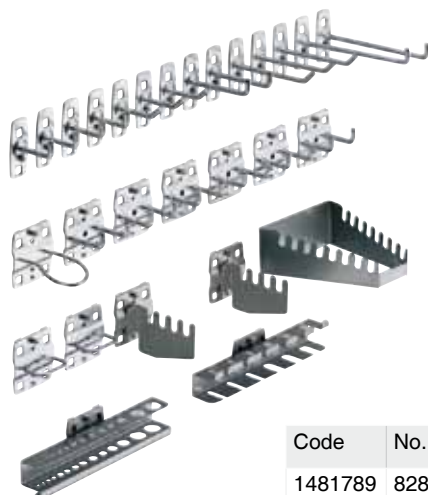
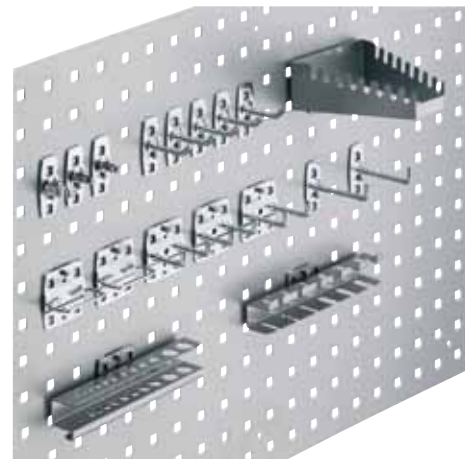

Code	No.	
1481789	82868	2000

82868 Hook assortment 28 pieces

Consisting of:

- Tool holder, inclined hook end: 3 pieces No. 82821 L= 50 mm, 3 pieces No. 82828 L= 100 mm
- Tool holder, straight mandrel: 4 pieces No. 82831 L=35 mm, 2 pieces No. 82832 L= 70 mm, 2 pieces No. 82833 L= 135 mm
- Tool holder, double, straight mandrel, 6 pieces No. 82837 L= 35 mm
- Machine holder Ø 4 mm, 1 piece No. 82875
- Pliers holder 2 pieces No. 82870 W= 35 mm
- Spanner holder, 1 piece No. 82824
- Screwdriver holder for 6 screwdrivers, 1 piece No. 82886
- Drill-bit holder, for 14 drills, 1 piece No. 82888
- Saw holder 2 pieces No. 82878
- Colour alu

Jordan-METEC Serie INDIVIDUAL

Expandable system device for the highest standards of quality, design and flexibility.
Facilities entire industrial objects and operations according to its own ideas with unique details such as drawer handle covers made of aluminum continuous casting, high-quality fittings etc.



Drawer Cabinets of Series Individual



- Expandable furniture system, ideal for industrial equipment object regions with highest quality demands
- In sturdy sheet steel construction with high-quality fittings technology in an attractive design
- Available at 2 heights (1000 and 850 mm) and 2 widths (715, 1021 mm), optional with chassis with 4 wheels an handle available
- Single drawer pull: Using this, we guarantee that only one drawer will open at a time, ensuring the greatest stability
- Design-drawes from extruded aluminium finish in 6 front panel heights 50,75,100, 150, 200 and 300 mm
- Drawers with full-depth pull-out, roller bearings, 75 kg load capacity per drawer
- alternativ by panel height 100 mm in heavy duty version up to 200 kg per Drawer, on request available (nicht für Fahrbetrieb geeignet)
- Drawer size inside: B 612 x D 612 mm bzw. B 918 x D 612 mm, individually partitionable
- Size: H 1000/ 850 x W 715/1021 x D 700 mm
- RAL 7016/ 7035



57177 Drawer cabinet

- W 715 x H 1000 mm
(Drawer size inside: W 612 x D 612 mm)



57177

Code	No.	H	W	D	Construction	
2900184	57177	1000	715	700	7  4x 75 1x 100 1x 200 1x 300	91,0

Code	No.	H	W	D	Construction	
2900186	57117	1000	1021	700	7  4x 75 1x 100 1x 200 1x 300	144,0

57117 Drawer cabinet

- W 1021 x H 1000 mm
(Drawer size inside: W 918 x D 612 mm)





57117



57875 Drawer cabinet

- W 715 x H 850 mm
(Drawer size inside: W 612 x D 612 mm)



57875

Code	No.	H	W	D	Construction	
2900185	57875	850	715	700	5  1x 50 2x 150 2x 200	94,0

Code	No.	H	W	D	Construction	
2900187	57815	850	1021	700	5  1x 50 2x 150 2x 200	116,0

57815 Drawer cabinet

- W 1021 x H 850 mm
(Drawer size inside: W 918 x D 612 mm)



57815





Drawer dividers for series individual

- Composed of 4 slotted plates right t/ left and ahead / behind and dividers, of powder-coated sheet steel and cross pieces of zinc-plated sheet steel, edges roundet
- Construction in 2 heights 50 mm and 125 mm
- For drawer size inside: W 612 x D 612 mm and W 918 x D 612

82190/57001-82190/57003 Dividet set H 50

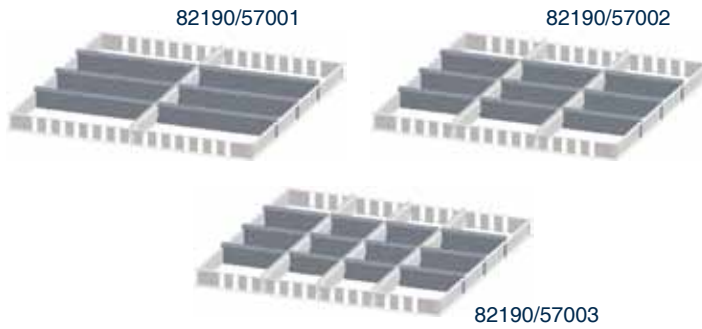
- For drawers with 75 mm / 100 mm front panel height
- Drawer size inside: 612 x 612 mm



Code	No.	Content	Divided into	
2900188	82190/57001	4 slotted plates 1 divider, 6 cross pieces	1/2	2,0
2900189	82190/57002	4 slotted plates 2 dividers, 9 cross pieces	1/3	2,5
2900190	82190/57003	4 slotted plates 3 dividers, 12 cross pieces	1/4	2,9

82190/57004-82190/57006 Divider set H 125

- For drawers with 150, 200, 300 mm front panel height
- Drawer size inside: 612 x 612 mm

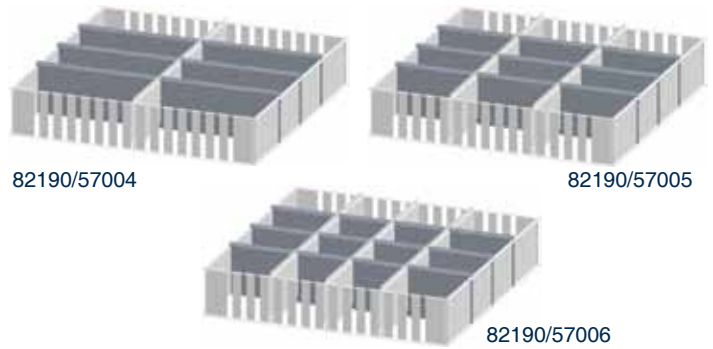

Code	No.	Content	Divided into	
2900191	82190/57004	4 slotted plates 1 divider, 6 cross pieces	1/2	4,7
2900192	82190/57005	4 slotted plates 2 dividers, 9 cross pieces	1/3	5,6
2900193	82190/57006	4 slotted plates 3 dividers, 12 cross pieces	1/4	6,5

82190/57007-82190/57009 Divider set H 50

- For drawers with 75 mm / 100 mm front panel height
- Drawer size inside: 918 x 612 mm



Code	No.	Content	Divided into	
2900194	82190/57007	4 slotted plates 2 dividers, 9 cross pieces	1/3	3,0
2900195	82190/57008	4 slotted plates 3 dividers, 12 cross pieces	1/4	3,4
2900196	82190/57009	4 slotted plates 4 dividers, 16 cross pieces	1/5	3,8

82190/57010-82190/57012 Divider set H 125

- For drawers with 150, 200, 300 mm front panel height
- Drawer size inside: 918 x 612 mm

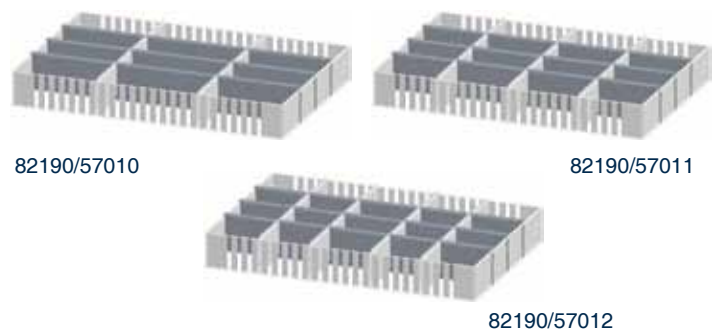

Code	No.	Content	Divided into	
2900213	82190/57010	4 slotted plates 2 dividers, 9 cross pieces	1/3	7,0
2900214	82190/57011	4 slotted plates 3 dividers, 12 cross pieces	1/4	7,9
2900215	82190/57012	4 slotted plates 4 dividers, 16 cross pieces	1/5	8,8



Accessories for Drawer Cabinets Series Individual

- Easy upgrade of drawer cabinets to a mobile drawer while substructure a chassis
- Simple extension of drawer cabinets for mobile drawer with the base of a chassis
- Chassis consisting of very stable load-bearing frame, screwed tightly, at initial equipment or to subsequent equipping usable (mounting material included)

- Wheel set 66801, 4 large wheels, Ø 150 mm, witch 2 swivel castors with brake, load capacity 480 kg
- Dimensions: W 709 / 1015 x D 640 x H 231 mm
- RAL 7016
- Sturdy handle for side mounting either right or left side of the Drawer case, suitable for all widths



59111 For drawer cabinet width 715 mm

Code	No.	H	W	D	
2560054	59111	231	709	640	23,0

59112 For drawer cabinet width 1021 mm

Code	No.	H	W	D	
2555298	59112	231	1015	640	25,0



59018 Trolley handle

Code	No.	W	D	
2544849	59018	470	80	0,6

Modular design of the individual-series

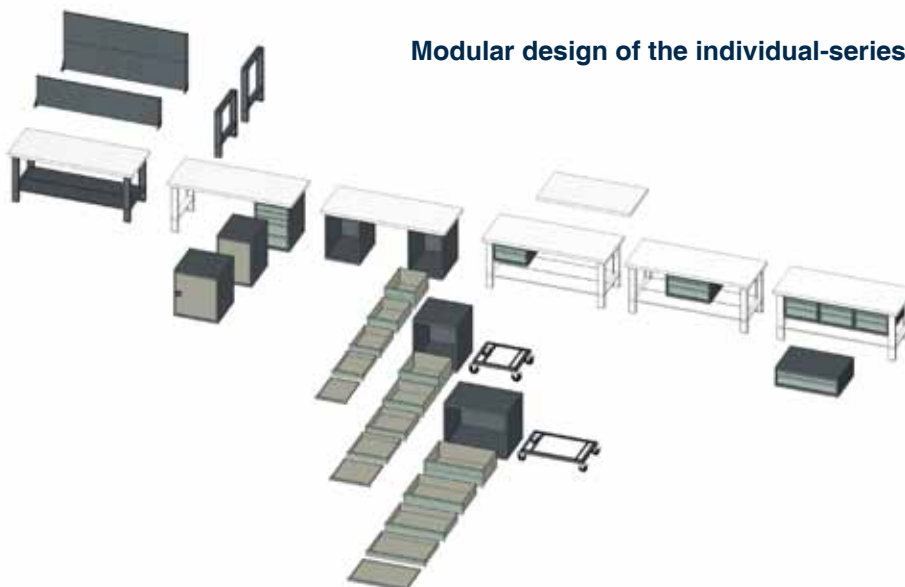

From individual parts to a complete piece of furniture

Configure workbenches according to their own wishes and ideas



Workbench legs:
 Different heights, or height adjustable workbench legs
 -600 mm height -750 mm height
 -650 mm height -800 mm height
 -700 mm height -850 mm height

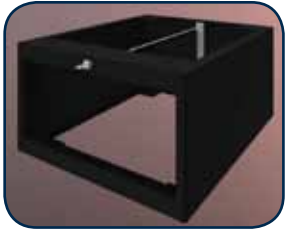

Drawer cabinets for submount:
 at 3 widths
 -562 mm
 -715 mm
 -1021 mm

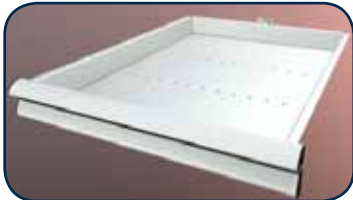

Drawer for drawer cabinets with different frontpanels suitable for drawer cabinets:
 -50 mm -150 mm
 -75 mm -200 mm
 -100 mm -300 mm



Rear wall and bottom plates as well side paneling for a secure and stable standing



Worktop:
 40 or 50 mm thick,
 750 or 800 mm depth,
 1500 or 2000 mm width

Complete offers for individual workbenches and row workbenches are possible.



pCon®.planner

Plan now easily book your rooms!

We offer a wide assortment of workshop furniture:

From simple workbench over the drawer cabinet up to the table trolley or to the wardrobe. Our standard catalog includes workshop equipment, to facilitate your daily work, to really good prices in best quality
- 100% MADE IN GERMANY by Jordan-METEC

What are you up to now only by planning your kitchen know, you can now with us, thanks to the pCon®.planner, simply use it for your planning of the workspaces.



The planning software pCon®.planner we enable you to be the first facility manufacturers the visualized set up in 3D.

Scheduling workshops and workrooms will use this software more efficient and easier to representation.

The software is easy to use and allows diverse perspectives of the artistic to photo-realistic representation of anything is possible.

You will also receive detailed product directly and commercial information for your goods economy.

pCon
PLANNER



How do you get the pCon®.planner?

It's easy!

- Visit us on www.metec.eu and click on the download link on the homepage.
- If you have questions or problems with the software, we support you at the following telephone number: +49 (0) 39266/760-15
- If you happen to one of our articles not included in pCon®.planner, we offer you this like to separately.
- Or, we make it to you ...
You give us the design of your Premises and send us this simple your floor plan.

Our range of Jordan Group of Companies in the sheet Structural Engineering

In addition to the production of high quality workshop furniture, we are also as a supplier in the sheet metal structural engineering works. We supply from simple sheet metal part to complex assemblies to housing customers throughout Germany.

Technically and organizationally we are well equipped. In the modern manufacturing dominated by CNC machines. Business processes and productions are controlled with the PPS system.

In the construction we work with the 3D design programs SolidWorks[®], HiCad & SheetWorks[®]. The software offers a very wide interface, which gives us the opportunity to take even 1:1 complex drawings from customers and further process.

New designs whose base is often just an idea, can be very quickly visualized and processed.

With our modern machinery, such as Punching and bending center, and much more more welding robot as well as our highly trained professionals, we are able to fulfill all your wishes in contract manufacturing: Least item lead times and low set-up costs even for small series.

In the surface, we work with its own powder coating plant with automatic guns, 4-chamber pretreatment and deionized water.

You can also visit the websites of our other specialists within the Group Jordan - www.jordan-gruppe.de

3D-Planning • Development • Punch • Lasers • Transform • Connect • Surface finishing • Mount



Case of an application for laser welding



Chassis for the dental industry



Chassis for optical process control in the placement technology



Special chassis - powder coated



Acoustic Enclosure for industrial compressors



Acoustic Enclosure for vacuum pump



Special chassis for IP design



Special stainless steel chassis



Detail View



Detail View



Front panel



Front panel - powder coated



Front panel - anodized and printed



Motor cable cover



Front panel - powder coated

Notes

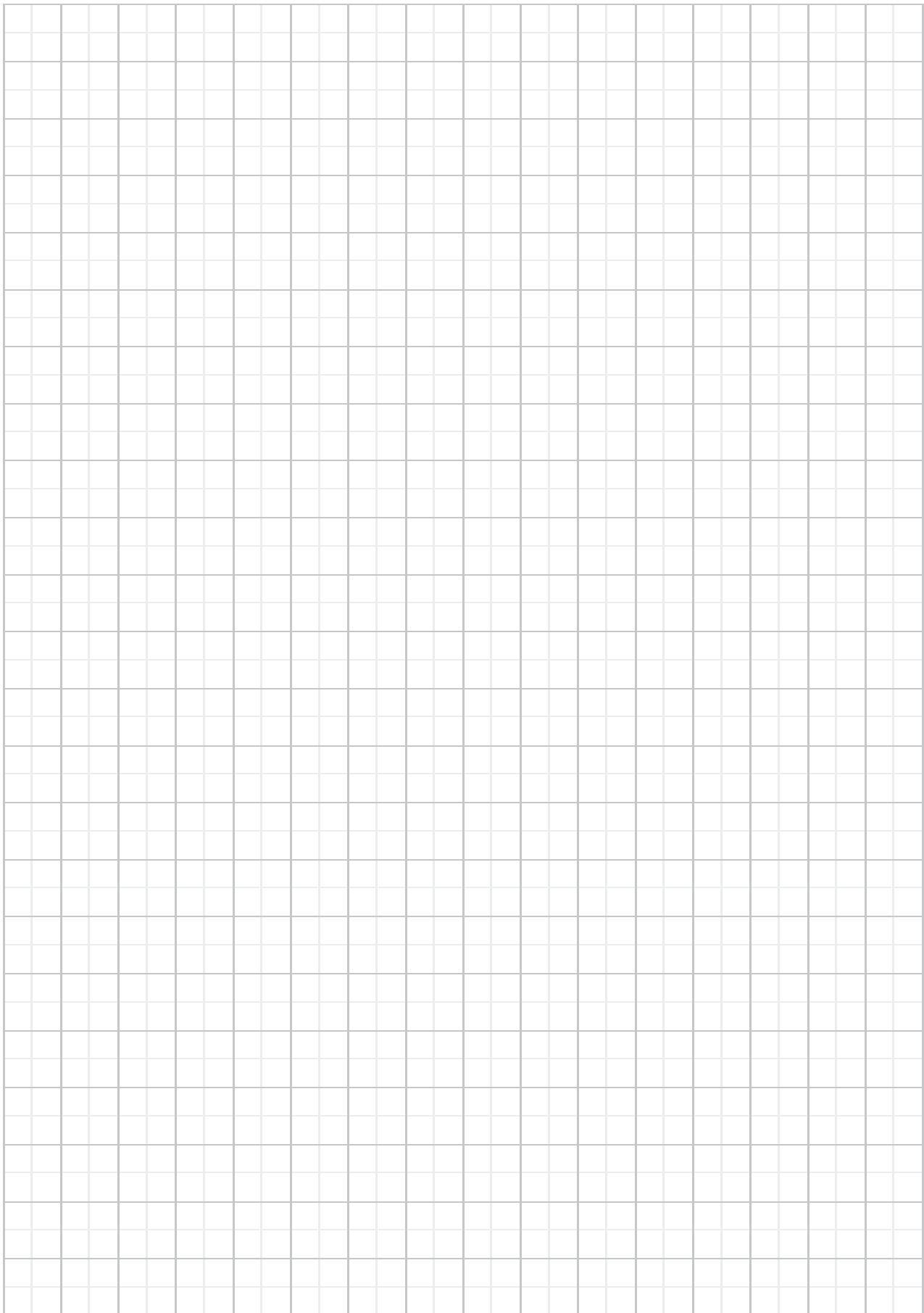

A large grid area for taking notes, consisting of a 20x30 grid of small squares.



Imprint

This catalog supersedes all previous issues. - Valid from april 2014 -

Photos and technical information is based on instantaneous stand.

With the improvement and adaptation of the prior art are subject to change with regard to appearance, dimensions, (if no other qualifier is always in mm), weight and properties as well as services available. Thus, there is no claim for compensation or replacement of already delivered products.

Deletions / changes can be made any time, without there is a legal claim.

All instructions for use and safety are non-binding. You should not supersede any statutory or trade association rules.

For printing errors, we assume no liability. Supplied with no decoration (tools, etc.) is included.

Reprinting, even in extracts, without the prior written consent.

All rights reserved worldwide.

Please refer to our current frame and condition agreements,
as well as our Shipping / Payment Terms and Conditions under www.metec.eu.

Design & realization

DER AUFDRUCK
„Wir machen Ihnen Druck“ & Design

Your (local) Dealer



JORDAN GmbH METEC Blechsysteme

Gewerbegebiet Süd 4
39443 Staßfurt OT Förderstedt
Germany
Phone: +49 (0) 39266 760 -0
Fax: +49 (0) 39266 760 -23

District Court Stendal, HRB 19594
E-Mail: info@metec.eu
www.metec.eu
www.jordan-gruppe.de